



User Manual

for 4G Series Grid Inverter - Solis-1P(3.6-5)K-4G-US



Applicable Models

Solis-1P3.6K-4G-US

Solis-1P5K-4G-US

Applicable System

Single phase Grid-Tie system

Important Notes

- Product specifications are subject to change without notice. Every attempt has been made to make this document complete, accurate and up-to-date. Individuals reviewing this document and installers or service personnel are cautioned, however, that Solis reserves the right to make changes without notice and shall not be responsible for any damages, including indirect, incidental or consequential damages caused by reliance on the material presented including, but not limited to, omissions, typographical errors, arithmetical errors or listing errors in the material provided in this document.
- Solis accepts no liability for customers' failure to comply with the instructions for correct installation and will not be held responsible for upstream or downstream systems Solis equipment has supplied.
- The customer is fully liable for any modifications made to the system; therefore, any hardware or software modification, manipulation, or alteration not expressly approved by the manufacturer shall result in the immediate cancellation of the warranty.
- Given the countless possible system configurations and installation environments, it is essential to verify adherence to the following:
 - There is sufficient space suitable for housing the equipment.
 - Airborne noise produced depending on the environment.
 - Potential flammability hazards.
- Solis will not be held liable for defects or malfunctions arising from:
 - Improper use of the equipment.
 - Deterioration resulting from transportation or particular environmental conditions.
 - Performing maintenance incorrectly or not at all.
 - Tampering or unsafe repairs.
 - Use or installation by unqualified persons.
- This product contains lethal voltages and should be installed by qualified electrical or service personnel having experience with lethal voltages.

Table of Contents

1 Introduction

2 Safety Instructions

3 Overview

4 Installation

5 Start and Stop

6 Operation

7 Maintenance

8 Troubleshooting

9 Specifications

10 Appendix

1. Introduction	1
1.1 Product Description	1
1.2 Inverter Knockouts	3
1.3 Wiring Box Interior View	3
1.4 Packaging	4
1.5 Tools Required for Installation	4
1.6 Storage	5
2. Safety Instructions	6
2.1 Safety Symbols	6
2.2 General Safety Instructions	6
2.3 Notice For Use	7
2.4 Notice For Disposal	7
3. Overview	8
3.1 Front Panel Display	8
3.2 LED Status Indicator Lights	8
3.3 Keypad	9
3.4 LCD	9
3.5 Wiring Circuit Diagram	9
4. Installation	10
4.1 Select Location for the Inverter	10
4.2 Mounting the Inverter	12
4.3 Electrical Connections	14
5. Start & Stop	21
5.1 Start-up procedure	21
5.2 Shutdown procedure	22

6. Operation	23
6.1 Main Menu	23
6.2 Information	23
6.3 Settings	24
6.4 Advanced Info.	25
6.5 Advanced Settings	29
6.6 ARC Fault	50
7. Maintenance	51
8. Troubleshooting	55
9. Specifications	56

1.1 Product Description

Solis single phase US series inverters can invert the DC power from (PV) solar modules into AC power which can support home loads and feed back to the grid.

This product manual is valid for the below listed Solis 1 ϕ inverters

1- Solis-1P3.6K-4G-US

2- Solis-1P5K-4G-US

1.1.1 Front View of the inverter

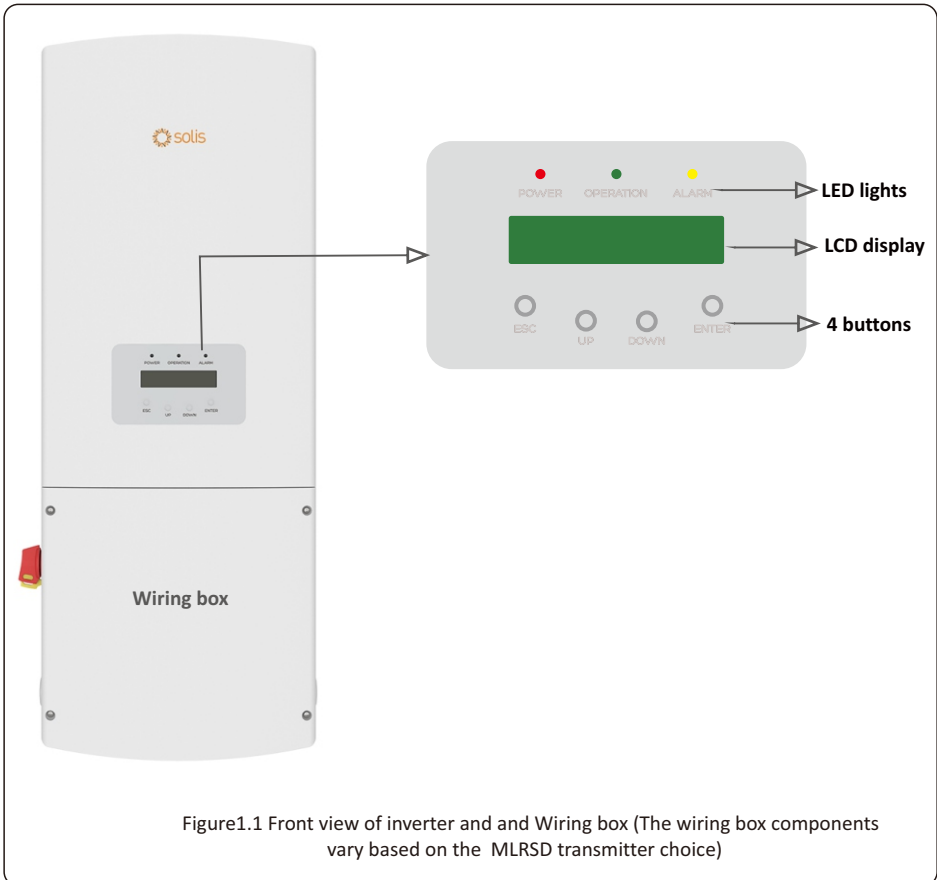

1.1.2 Bottom and Side View

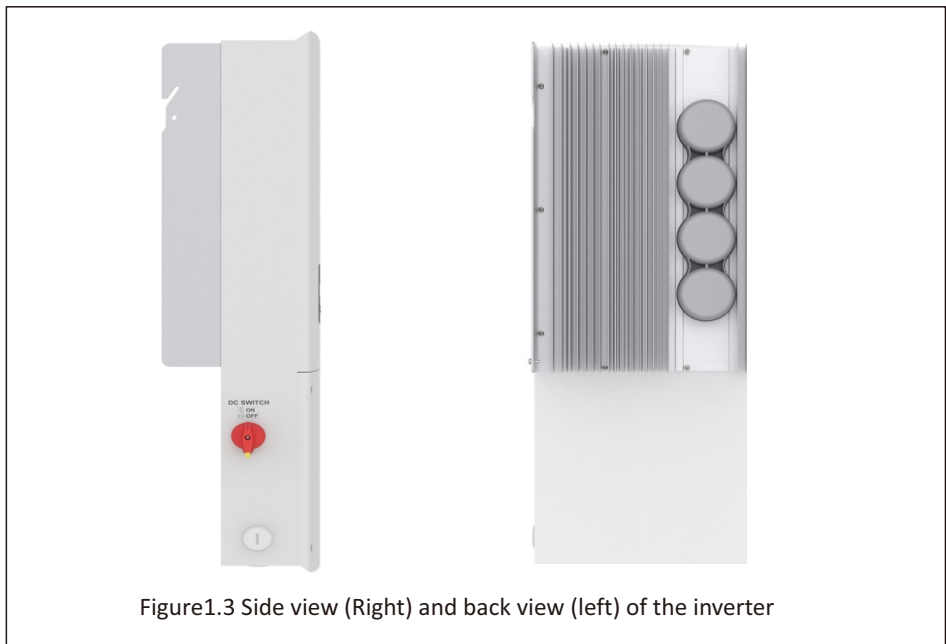
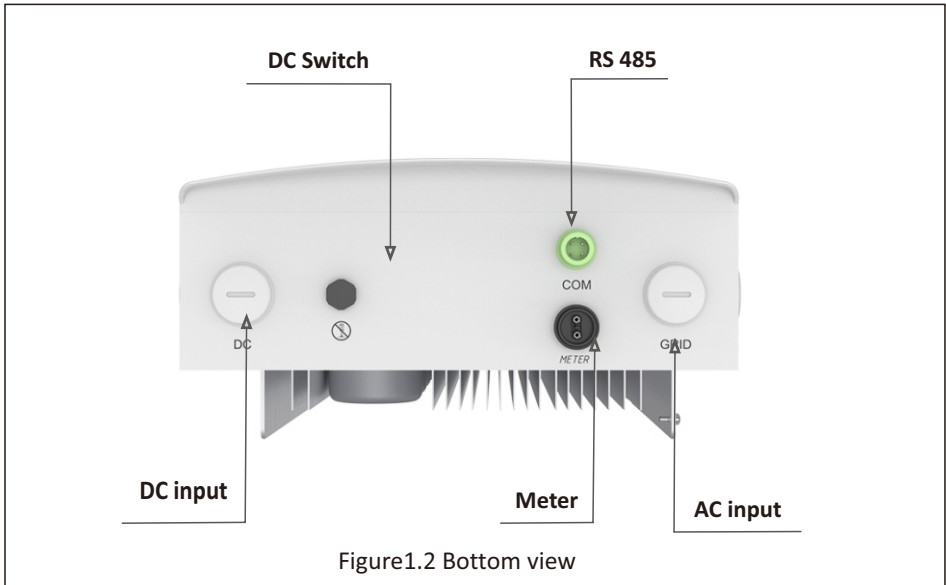

1.2 Inverter Knockouts

The inverter comes equipped with the following knockouts at the bottom, back and the side of the wiring box, Adding additional knockouts shall void the inverter warranty

Location	Quantity	Size of Conduit	Purpose
Bottom	2	1 x 3/4" 1 x 3/4"	Knockout for DC input, DC input and communication cable
Right Side	1	1 x 3/4"	knockout for AC output cable
Left Side	1	1 x 3/4"	knockout for DC input cable

Table 1.1 Knockout quantity and size

1.3 Wiring Box Interior View

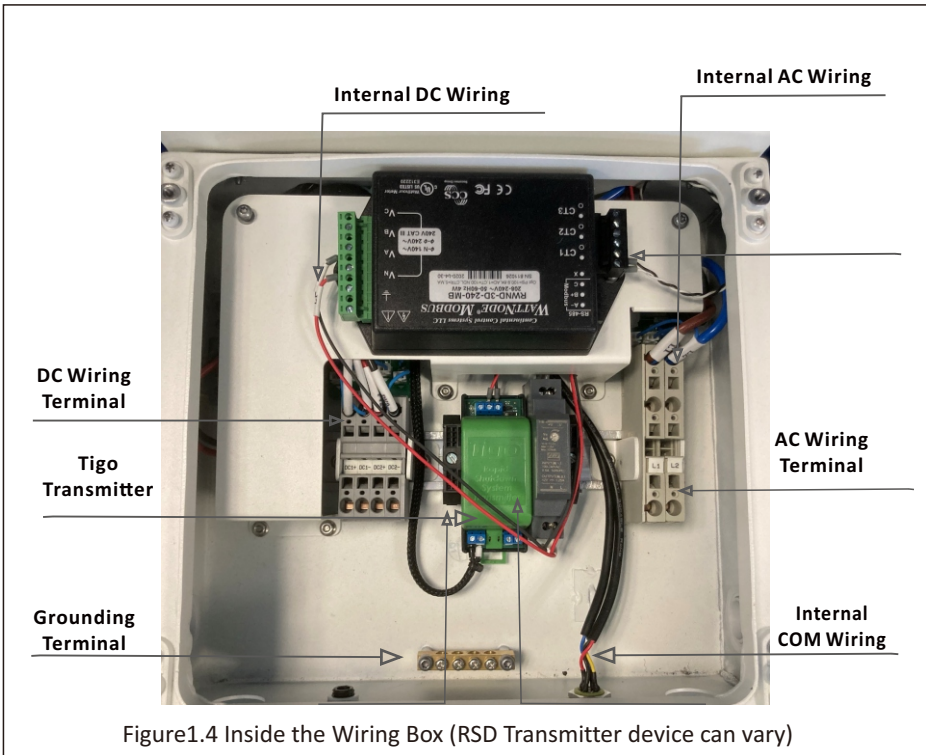

1.4 Packaging

When you receive the inverter, ensure a thorough inspection for any visible damage to the packing case or the products and ensure that all the parts listed below are included:

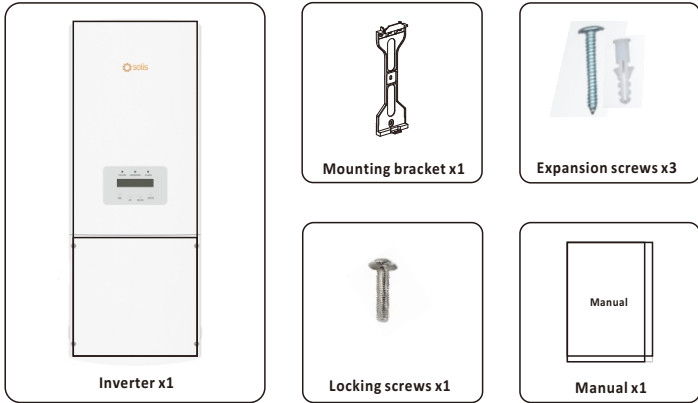

In case of any damage and missing component, contact Solis US Service team at ussales@solisinverters.com

1.5 Tools Required for Installation

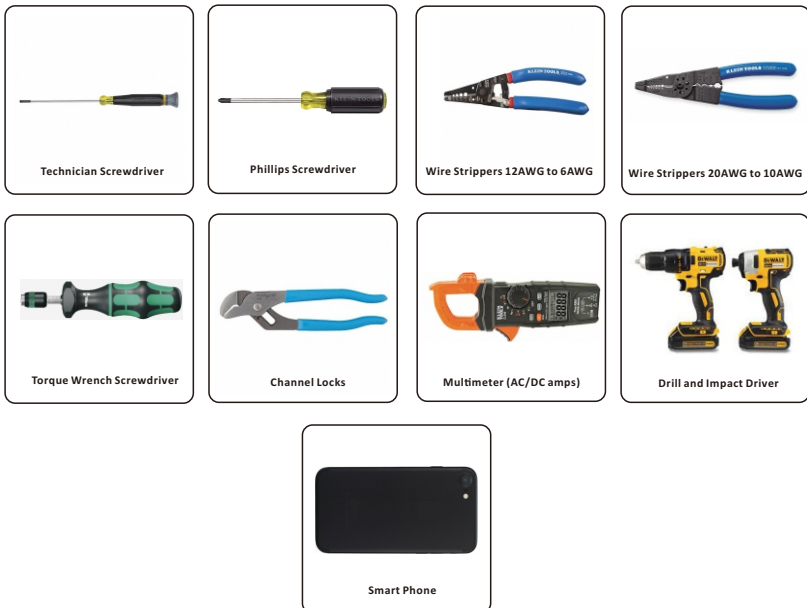

1.6 Storage

If the inverter is not installed immediately, the following storage instructions and environmental conditions must be followed

- Use the original packing box with the desiccant inside to pack the inverter.
- Store the inverter in a clean and dry place, free of dust and dirt. The storage temperature must be between -13°F to 176°F and humidity should be between 0 to 95%, non-condensing.
- Do not stack more than four (4) inverters high on a single pallet.
- Keep the box(es) away from corrosive materials to avoid damage to the inverter enclosure.
- Inspect the packaging regularly. If packing is damaged (wet, pest damages, etc.), repackage the inverter immediately.
- Store inverters on a flat, hard surface -- not inclined or upside down.
- After 100 days of storage, the inverter and carton must be inspected for physical damage before installing. If stored for more than 1 year, the inverter needs to be fully examined and tested by qualified service or electrical personnel before using.
- Restarting after a long period of non-use requires the equipment be inspected and, in some cases, the removal of oxidation and dust that has settled inside the equipment will be required.
- Improper use may result in potential electric shock hazards or burns. This manual contains important instructions that should be followed during installation and maintenance.

SAVE THESE INSTRUCTIONS – This manual contains important instructions for the following models that shall be followed during installation and maintenance of the inverter

Solis-1P3.6K-4G-US

Solis-1P5K-4G-US

2.1 Safety Symbols

Safety symbols used in this manual, which highlight potential safety risks and important safety information, are listed as follows:



WARNING

WARNING symbol indicates important safety instructions, which if not correctly followed, could result in serious injury or death.



NOTE

NOTE symbol indicates important safety instructions, which if not correctly followed, could result in equipment or property damage



CAUTION: RISK OF ELECTRIC SHOCK

Symbol indicates important safety instructions, which if not correctly followed, could result in electric shock.



CAUTION: CAUTION, HOT SURFACE

Symbol indicates safety instructions, which if not correctly followed, could result in burns.

2.2 General Safety Instructions



WARNING

Do not connect PV array positive(+) or negative(-) to ground, it may cause serious damage to the inverter.



WARNING

Electrical installations must be done in accordance with the local and national electrical safety standards.



WARNING

To reduce the risk of fire, over-current protective devices (OCPD) are required for circuits connected to the Inverter. The DC OCPD shall be installed per local requirements. All photovoltaic source and output circuit conductors shall have disconnects that comply with the NEC Article 690, Part II. All Solis single phase inverters feature an integrated DC switch.



CAUTION

Risk of electric shock. Do not remove cover. There is no user serviceable parts inside. Refer servicing to qualified and accredited service technicians.



CAUTION

The PV array (solar panels) supplies a DC voltage when they are exposed to sunlight.



CAUTION

Risk of electric shock from energy stored in capacitors of the inverter. Do not remove cover for 5 minutes after disconnecting all power sources(service technician only). Warranty may be voided if the cover is removed without unauthorized .



CAUTION

The surface temperature of the inverter can reach up to 75°C (167 F). To avoid risk of burns, do not touch the surface of the inverter while it's operating. Inverter must be installed in a place inaccessible to children.

2.3 Notice For Use

The inverter has been constructed according to the applicable safety and technical guidelines. Use the inverter in installations that meet the following specifications ONLY:

1. Permanent installation is required.
2. The electrical installation must meet all the applicable regulations and standards.
3. The inverter must be installed according to the instructions stated in this manual.
4. The inverter must be installed according to the correct technical specifications.

2.4 Notice for Disposal

This product shall not be disposed of with household waste. It must be segregated and brought to an appropriate disposal facility to ensure proper recycling. This it to be done in order to avoid negative impacts on the environment and human health. Local waste management rules shall be observed and respected.



3.1 Front Panel Display

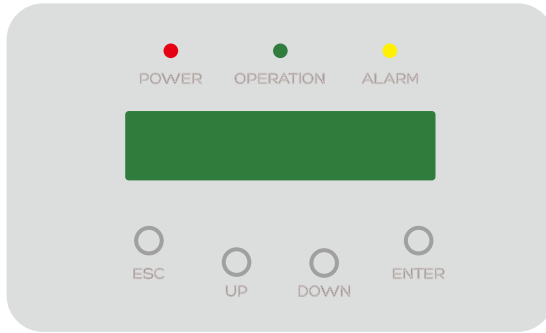

Figure 3.1 Front Panel Display

3.2 LED Status Indicator Lights

There are three LED status indicator lights in the front panel of the inverter.

- POWER LED (red) indicates the power status of the inverter.
- OPERATION LED (green) indicates the operation status.
- ALARM LED (yellow) indicates the alarm status.

Light	Status	Description
● POWER	ON	The inverter detects DC power.
	OFF	No DC power or low DC power.
● OPERATION	ON	The inverter is operating properly.
	OFF	The inverter has stopped producing power.
	FLASHING	The inverter is initializing Updating software
● ALARM	ON	Alarm or fault condition is detected.
	OFF	No fault or alarm is detected.

Table 3.1 Status Indicator Lights

3.3 Keypad

There are four keys in the front panel of the inverter (from left to right): ESC, UP, DOWN and ENTER keys. The keypad is used for:

- Scrolling through the inverter menus (the UP and DOWN keys);
- Access to modify the adjustable settings (the ESC and ENTER keys).

3.4 LCD

The two-line Liquid Crystal Display (LCD) is located on the front panel of the Inverter, which shows the following information:

- Inverter operation status and data;
- Service messages for operator;
- Alarm messages and fault indications.

3.5 System Diagram

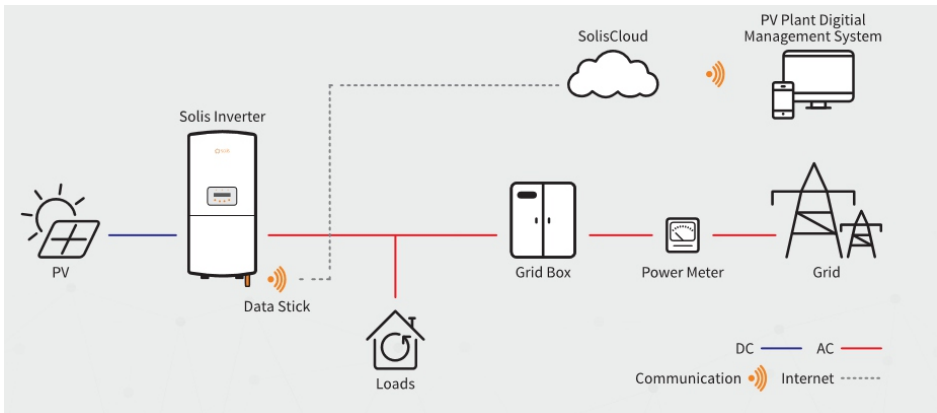

4.1 Select a Location for the Inverter

To select a location for the inverter mounting for safe operation and easy maintenance, the following criteria should be considered:



WARNING: Risk of fire

Despite careful construction, electrical devices can cause fires.

- Do not install the inverter in areas containing highly flammable materials or gases.
- Do not install the inverter in potentially explosive atmospheres.

- To avoid overheating, always make sure there is enough free space for air circulation around the inverter .
- Exposure to direct sunlight will increase the operational temperature of the inverter and may limit the output power. Thus it is recommended to protect the inverter against direct sunlight or rain or snow.
- The ambient temperature and relative humidity should meet the following requirements.
Operating Temperature Range: -13°F to 140°F (-25°C to 60°C)
Relative Humidity: 0~95%
- It is recommended to use a sun shade minimizing direct sunlight when the ambient air temperature around the unit exceeds 104°F/40°C.

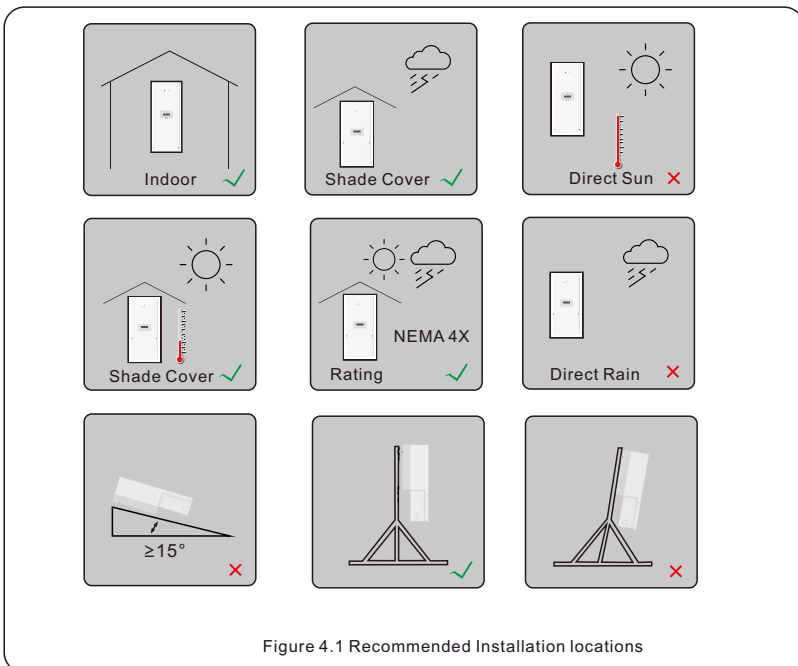
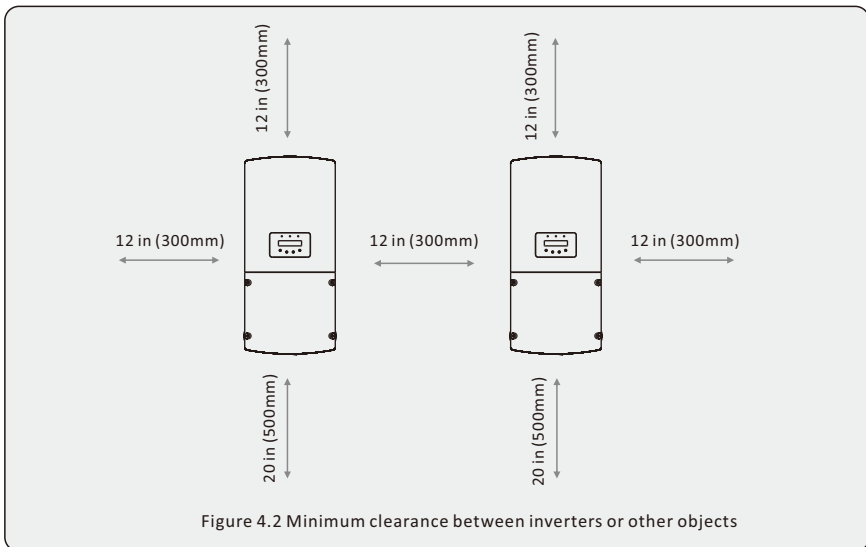

Figure 4.1 Recommended Installation locations

- It is not recommended that the inverter is installed in living areas to avoid building users to be bothered by inverter noise during operation.
- The inverter should be installed in a place that is inaccessible to the children.
- Install on a wall or strong structure that is capable of bearing the weight.
- Install vertically with a maximum incline of $\pm 5^\circ$. If the mounted inverter is tilted to an angle greater than $\pm 5^\circ$, heat dissipation will be inhibited, and may result in derating.
- For multiple adjacent inverters, a minimum clearance of 12 inches should be kept between each inverter or other objects to have adequate air flow. The bottom of the inverter should have 20 inches of clearance to the ground as shown below.



- Visibility of the LED status indicator lights and the LCD located at the front panel of the inverter should be considered.
- Adequate ventilation must be provided if the inverter is to be installed in a confined space.



NOTE

Nothing should be stored on or placed against the inverter.

4.2 Mounting the Inverter

Dimensions of mounting bracket:

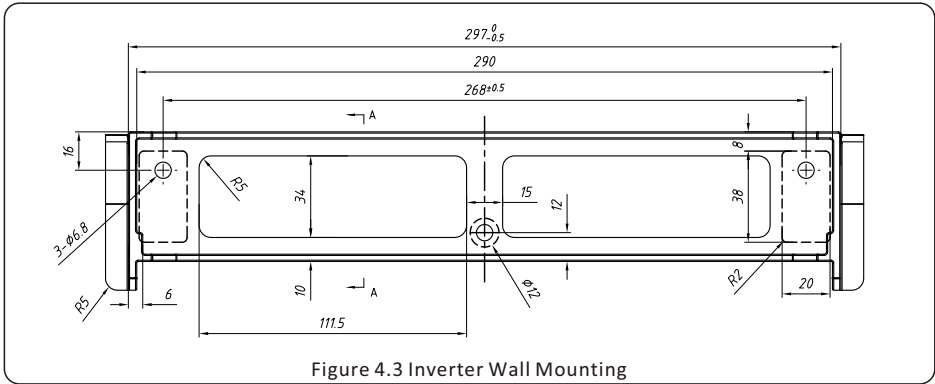

Figure 4.3 Inverter Wall Mounting

Please see Figure 4.4 and Figure 4.5 for instruction on mounting the inverter to a wall. The inverter shall be mounted vertically. The steps to mount the inverter are listed below:

1. According to the figure 4.3, select the mounting height of the bracket and mark the mounting holes. For brick walls, the position of the holes should be suitable for the expansion bolts.

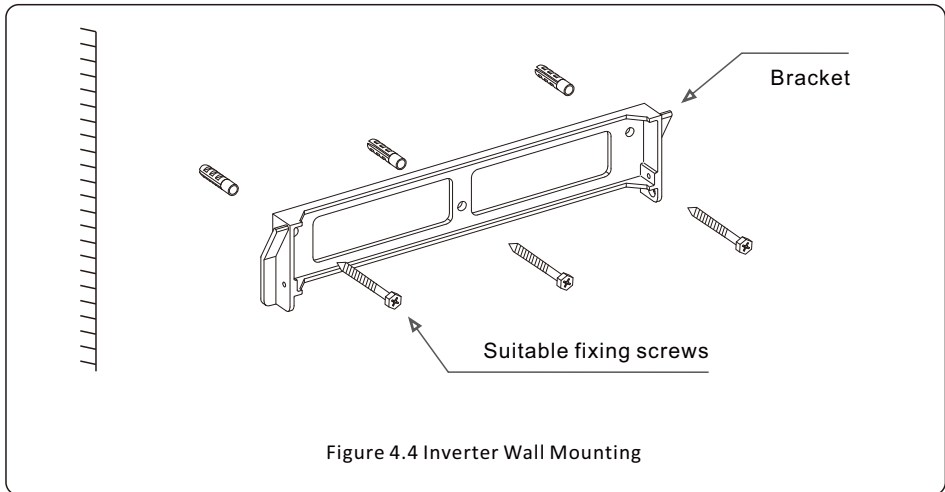
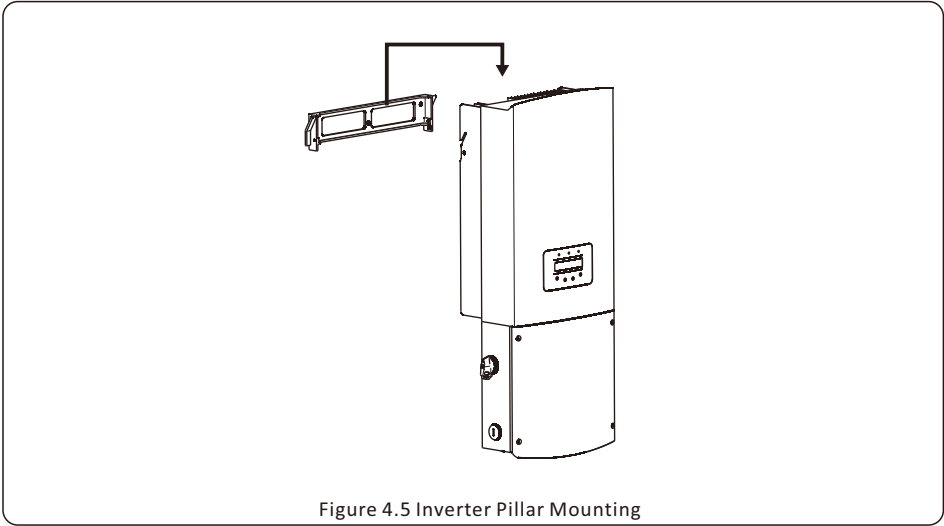

Figure 4.4 Inverter Wall Mounting

2. Ensure the bracket is horizontal and the mounting holes (in Figure 4.4 and Figure 4.5) are marked correctly. Drill the holes into the wall or pillar as marked.
3. Use the expansion screws marked in figure 4.4 to fix the bracket to the wall.



4. Lift up the inverter (be careful to avoid body strain), and align the back bracket on the inverter with the convex section of the mounting bracket. Hang the inverter on the mounting bracket and ensure the inverter is secure (see Figure 4.5)



WARNING

The inverter must be mounted vertically.

5. Use M4*9 screws in accessory to lock the inverter to the mount bracket.

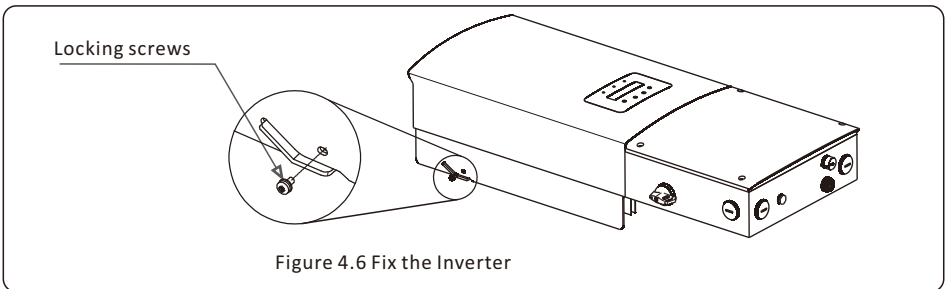

CAUTION

It is recommended that at least 2 qualified personnel lift the inverter to avoid any personal injury.

4.3 Electrical Connections

Remove the four screws on both sides of the wiring box with the screw driver, then remove the cover.



WARNING

Only qualified personnel can perform the electrical work. All electrical connections must be terminated in accordance with local and national standards.



NOTE

Press on the wiring box cover while loosening the screws. This action will help to avoid damaging the screw threads.



WARNING

The PV strings generate high voltage so make sure the inverter is isolated from any DC and AC power before making any electrical connections

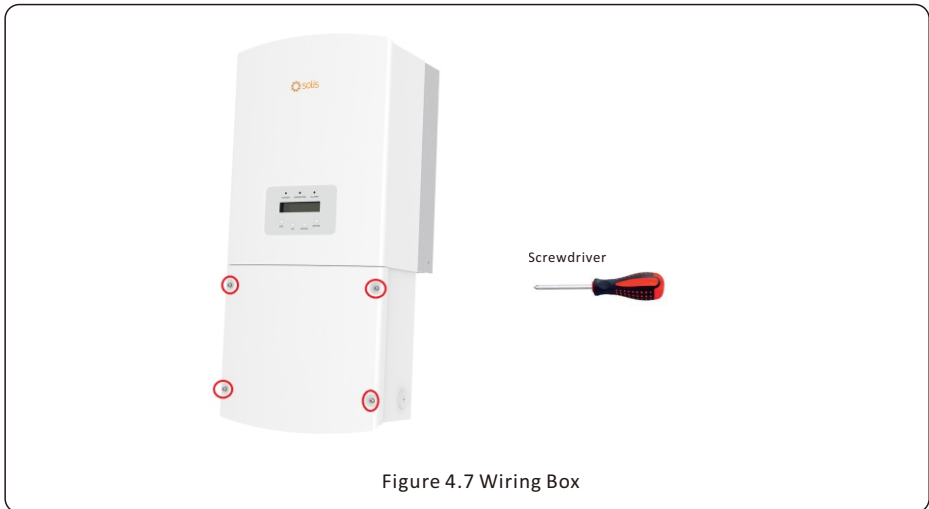

Figure 4.7 Wiring Box

Before making electrical connections, double check to ensure the steps below are strictly followed:

- a. Switch the Grid Supply Main Switch (AC) OFF.
- b. Switch the DC Switch OFF.

The two knockouts on the left (bottom and side) are for the DC conduit entry. The two knockouts on the right (bottom and side) are for the AC conduit entry. All knockouts in the wiring box can accept trade size **1 inch (ID) conduit**.

4.3.1 Terminal Connections

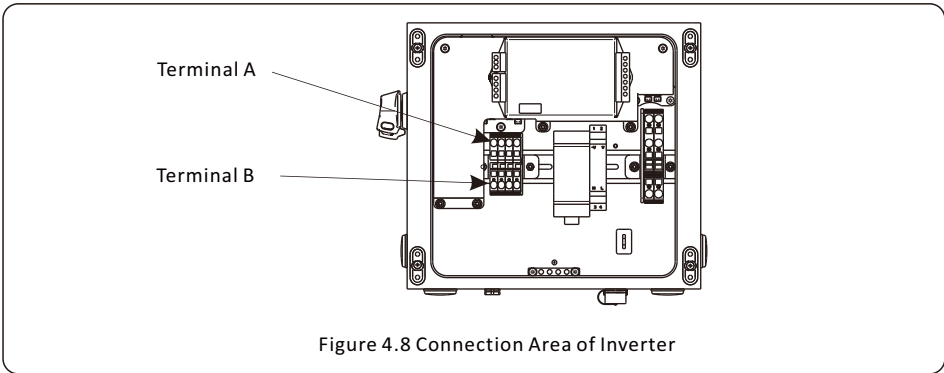

Figure 4.8 Connection Area of Inverter

Strip the end of the wire 1/4" minimum to 3/4" maximum. Use a slotted (technician) screwdriver, insert the screwdriver in Terminal A (top) and insert the wire into Terminal B (bottom) of the spring clamp terminal. While holding the wire in place, remove the screwdriver and the spring clamp terminal will fix the wire in place. Use the labels on the wiring block to ensure proper polarity and a multi-meter to verify the PV polarity.

4.3.2 Connect PV Side of Inverter



Warning

Before connecting the inverter, ensure the PV string open circuit voltage is within the limit of the inverter. Otherwise the inverter could be damaged.



DO NOT connect the PV array positive or negative to ground. check the ground fault This can cause serious damage to the inverter.



Before connection, ensure the PV array strings are correct polarity and match the proper "DC+" and "DC-" symbols you will connect them to.

Cable type	Cross section	
	Range	Recommended value
Industry generic PV cable (model:PV1-F)	4.0~6.0mm ² (12~10AWG)	4.0mm ² (12AWG)

Table 4.1 DC cable size



Do not enlarge the existing conduit knockouts or drill hole. Doing so could allow moisture to penetrate the inverter wire box, which could damage electronic components in the inverter and void the warranty.

Please refer to figure 4.9, The acceptable wire size range is from 12 AWG to 8 AWG, copper conductors only; refer to local code for appropriate wire size.



CAUTION

If the PV strings are accidentally connected in reverse or inverter is faulty or not working properly, do not turn off the DC switch. Otherwise it may cause DC arc and damage the inverter or even lead to a fire disaster.

The correct actions are:

- *Use a DC clampmeter to measure the DC string current.
- *If it is above 0.5A, please wait for the solar irradiance decrease until the DC current is below 0.5A.
- *Only after the current is below 0.5A, then you it is safe to turn off the DC switch and disconnect the PV strings.
- * In order to completely eliminate the possibility of failure, please disconnect the PV strings after turning off the DC switch to avoid secondary failures due to continuous PV energy the next day.

Please note that any damages due to wrong operations are not covered in the inverter warranty.

4.3.3 Connect Grid Side of Inverter

The Solis Single Phase inverters can be connected to a 208V or 240V grid. The default setting is for a 240VAC single phase grid. Ground must be connected to the PE terminal.



Cable type	Cross section	
	Range	Recommended value
Industry generic grid cable	4~25mm ² (12~4AWG)	10-25mm ² (8-4AWG)

Table 4.2 AC cable size

Figure 4.10 AC Connection Area of Inverter

There are two cable connection points for each phase, one for grid, one for AC power of RSD.

GRID STANDARD						
	208V~ 3PH-Δ-3W			240V~ SPLIT-PHASE		
TERMINAL	L1	L2	N	L1	L2	N
Connection requirement	Yes	Yes	No	Yes	Yes	No

Table 4.3 Grid Terminal Connection

4.3.4 Ground Connection

Internal ground connection point

Both DC and AC ground cable can be connect to ground terminal in the wiring box, refer to figure 4.10 below. The acceptable wire size for ground is **12AWG to 8 AWG**. The torque setting is 26 in-lbs (3 Nm) .

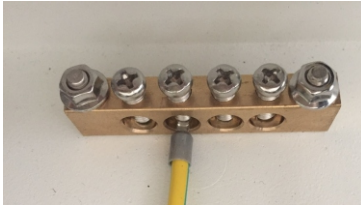

Figure 4.9 Grounding Terminal on Heat-Sink

External ground connection point

An external ground connection is provided at the right side of the inverter. Prepare OT terminals: M4. Use proper tools to crimp the lug to the terminal. Connect the OT terminal with ground cable to the right side of the inverter. The torque setting is 20 in-lbs (2Nm).

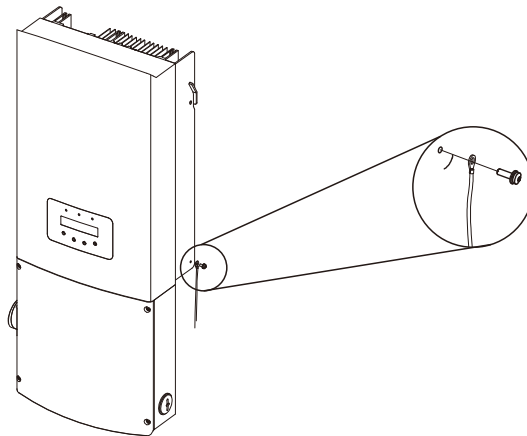

Figure4.10 Connect the External Grounding Conductor

4.3.5 Max. Overcurrent Protection Device (OCPD)

Overcurrent Protection Device (OCPD) shall be installed to protect the inverter and AC grid conductors from over current, The conductors and overprotection devices shall be designed in accordance with the local jurisdiction and NEC.

4.3.6 Inverter Monitoring Connection

The inverter can be monitored remotely if a Solis data logger is installed. Solis data loggers use LAN, WiFi, and cellular communication. All Solis communication devices are optional (Figure 4.9). For connection instructions, please refer to the Solis Monitoring Device installation manuals.

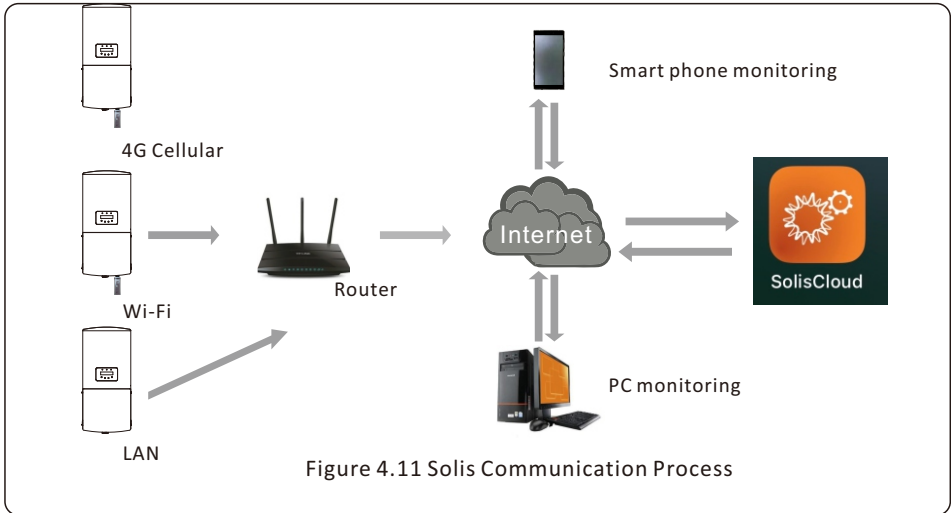

4.3.7 Module Level Rapid Shutdown (MLRSD)

For systems that are required to meet NEC 690.12, This product provides a module level shutdown feature that brings the panel voltage to a safe level to reduce shock hazard for firefighters .

NOTE



The Solis single phase inverters either come with integrated Tigo or APS transmitter. For MLRSD detailed installation please refer to the user manual of MLRSD Providers. E.g. if Tigo transmitter is installed inside the inverter wiring box, customer must install corresponding Tigo module level rapid shutdown devices. Please consult Tigo or APS for detailed instructions.

4.3.8 Meter Connection(optional)

The inverter can work with a split phase smart Solis Acrel meter to achieve Export Power Management function. Below is the connection diagram, for detailed settings please refer to Section 6.5.11. .

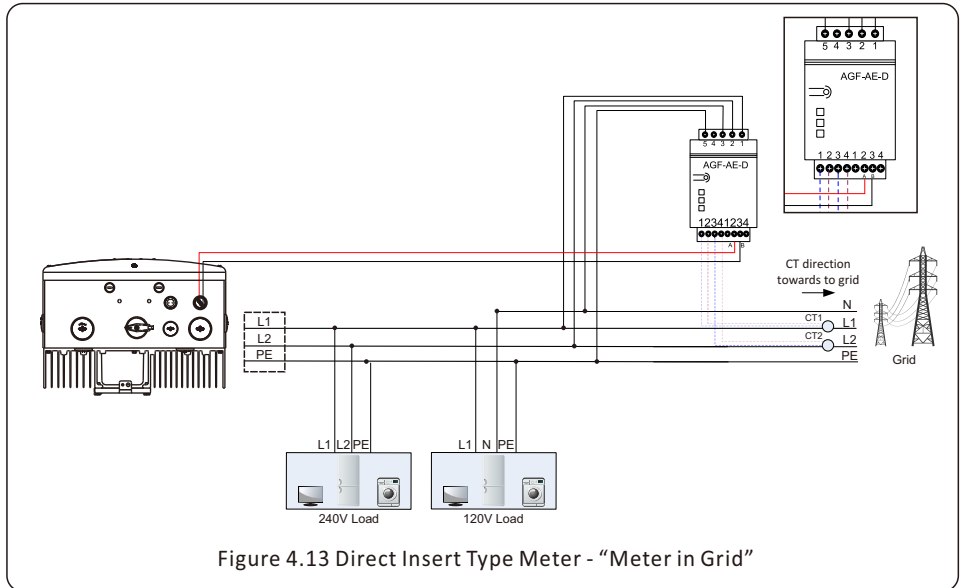

The CTs must be installed facing the right direction, otherwise the inverter will not function normally. The CT arrows must face towards the grid.

5.1 Start-up procedure

To start-up the inverter, it is mandatory that the steps below are followed in the exact order outlined.

1. Turn the AC switch ON.
2. Turn on any external DC switches, if the system has any. Then turn the inverter DC switches ON. If the PV array (DC) voltage is higher than the inverter start-up voltage, the inverter will turn on. The red DC POWER LED and LCD will be continuously lit.
3. Solis inverters are powered from the DC side. When the inverter detects DC power that is within start-up and operating ranges, the inverter will turn on. After turn-on, the inverter will check internal parameters, sense and monitor AC voltage, hertz rate and the stability of the grid supply. During this period, the green OPERATION LED will flash and the LCD screen will show **INITIALIZING**. This tells the operator that the inverter is preparing to generate AC power.
4. After the locally mandated delay (300 seconds for IEEE-1547 compliant inverters), the inverter will start generating AC power. The green OPERATION LED will light continuously and the LCD screen will show **GENERATING**.



CAUTION

The surface temperature of the inverter can reach up to 75°C (167 F). To avoid risk of burns, do not touch the surface of the inverter while it's operating. Inverter must be installed in a place inaccessible to children.

5.2 Shutdown procedure

To stop the inverter, it is mandatory to follow the below steps in the exact order outlined.

1. Under advanced setting of inverter LCD, select "Grid Off" (Refer to section 6.5.2 for more details). Technician will see the Green Operation LED go dark. The inverter may indicate a NO GRID alarm and the technician may see a Yellow Alarm LED illuminate. The RED Power LED will stay lit until dc power is removed.
2. Turn off the AC Switch between Solis inverter and the Grid to disable AC power to the inverter.
3. Wait approximately 30 seconds (during this time, the AC side capacitors are dissipating energy). If the inverter has DC voltage above the start-up threshold, the red POWER LED will be lit. Turn the DC switch OFF.
4. Confirm all LED's switch OFF (~one (1) minute).

CAUTION



Although the inverter DC disconnect switch is in the OFF position and all the LED's are OFF, operators must wait five (5) minutes after the DC power source has been disconnected before opening the inverter cabinet. DC side capacitors can take up to five (5) minutes to dissipate all stored energy.

If you are not able to resolve the alarm code using the troubleshooting steps, or if the alarm code you are seeing is not listed, please contact Solis customer support.

Please also take note of the inverter model number, serial number, and internal transmitter type.

Contact details are given below:

Solis US Technical Support Phone Number: +1(866)438-8408

Solis US Technical Support email: usservice@solisinverters.com

During normal operation, the display alternately shows the power and the operation status with each screen lasting for 10 seconds. Screens can also be scrolled manually by pressing the UP and DOWN keys(see Figure 6.1). Press the ENTER key to access to the Main Menu. Pressing the ESC key calls back the previous menu.

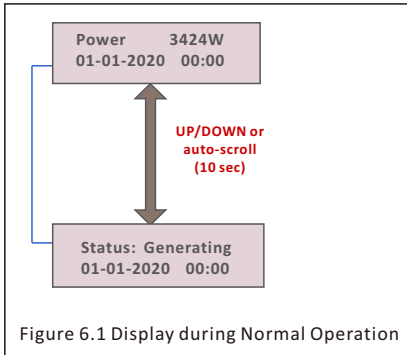

Figure 6.1 Display during Normal Operation

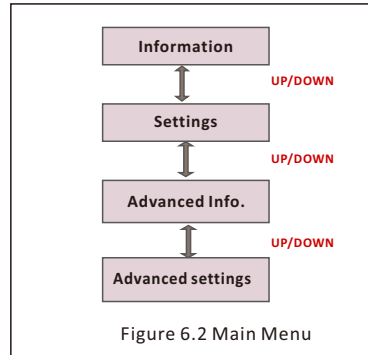

Figure 6.2 Main Menu

Lock Screen: Pressing the ESC key returns to the Main Menu. Pressing the ENTER key locks (Figure 6.3(a)) or unlocks (Figure 6.3 (b)) the screen.

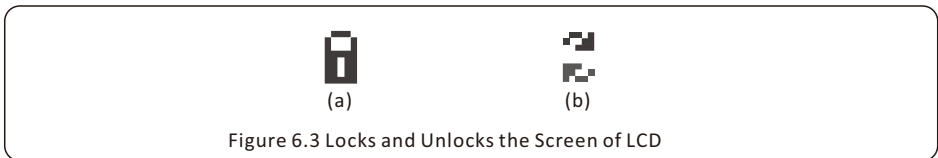

Figure 6.3 Locks and Unlocks the Screen of LCD

6.1 Main Menu

There are four submenus in the Main Menu (see Figure 6.2):

1. Information
2. Settings
3. Advanced Info.
4. Advanced Settings

6.2. Information

The Solis single phase inverter main menu provides access to operational data and information. Below list shows is the inverter display information under the “information” sub menu along with the description of each section. The information is displayed by selecting “Information” from the menu and then by scrolling up or down.

Display	Duration	Description
V_DC1 350.8V I_DC1 5.1A	10 sec	V_DC1: Shows input 01 voltage value. I_DC1: Shows input 01 current value.
V_DC2 350.8V I_DC2 5.1A	10 sec	V_DC2: Shows input 02 voltage value. I_DC2: Shows input 02 current value.
V_Grid 230.4V I_Grid 8.1A	10 sec	V_Grid: Shows the grid's voltage value I_Grid: Shows the grid's current value.
Status: Generating Power: 1488W	10 sec	Status: Shows instant status of the Inverter. Power: Shows instant output power value.
Grid Frequency F_Grid 60.06Hz	10 sec	F_Grid: Shows the grid's frequency value.
Total Energy 0258458 kwh	10 sec	Total generated energy value.
This Month: 0123kwh Last Month: 0123kwh	10 sec	This Month: Total energy generated this month. Last Month: Total energy generated last month.
Today: 15.1kwh Yesterday: 13.5kwh	10 sec	Today: Total energy generated today. Yesterday: Total energy generated yesterday.
Inverter SN 00000000000000	10 sec	Display series number of the inverter.
Export_P: +0000W Export_I: 00.0A	10 sec	Power of EPM. Current of EPM.
Work Mode: NULL DRM Number: 08	10 sec	Work Mode: The work mode of inverter. DRM Number: Show the number 01–08.
Meter EnergyP 0000000.00kWh	10 sec	Meter EnergyP: The active power.

Table 6.1 Information list

6.3. Settings

The following submenus are displayed when the Settings menu is selected:

- 1. Set Time
- 2. Set Address

6.3.1. Set Time

This function allows time and date setting. When this function is selected, the LCD will display a screen as shown in Figure 6.4.

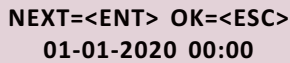

NEXT=<ENT> OK=<ESC>
01-01-2020 00:00

Figure 6.4 Set Time

Press the UP/DOWN keys to set time and data. Press the ENTER key to move from one digit to the next (from left to right). Press the ESC key to save the settings and return to the previous menu.

6.3.2. Set Address

This function is used to set the address when muti inverters are connected to single monitor. The address number can be assigned from “01”to “99”. The default address is “01”.

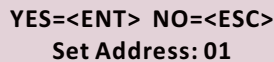

YES=<ENT> NO=<ESC>
Set Address: 01

Figure 6.5 Set Address

Press the UP/DOWN keys to set the address. Press the ENTER key to save the settings. Press the ESC key to cancel the change and return to the previous menu.

6.4. Advanced Info - Technicians Only



NOTE:

To access to this area is for fully qualified and accredited technicians only. Enter menu “Advanced Info.” and “Advanced settings” (need password).

Select “Advanced Info.” from the Main Menu. The screen will require the password as below:

YES=<ENT> NO=<ESC>
Password:0000

Figure 6.6 Enter password

The default password is “0010”. Press “down” “down” “up” and “enter” to select the number. After enter the correct password, the Main Menu will display a screen and be able to access the following information.

1. Alarm Message
2. Running message
3. Version
4. Daily Energy
5. Monthly Energy
6. Yearly Energy
7. Daily Record
8. Communication Data
9. Warning Message

6.4.1. Alarm Message

The display shows the 100 latest alarm messages (see Figure 6.7). Screens can be scrolled manually by pressing the UP/ DOWN keys. Press the ESC key to return to the previous menu.

Alarm001: OV-G-V
Time: 00-00 Data: 7171

Figure 6.7 Alarm Message

6.4.2. Running Message

This function is for maintenance personnel to get running message such as internal temp., Standard No.etc. Screens can be scrolled manually by pressing the UP/DOWN keys.

Model: 08
Software Version: D20001

Figure 6.7 Alarm Message

6.4.3. Version

The screen shows the model version and the software version of the Inverter

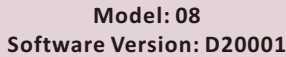

Model: 08
Software Version: D20001

Figure 6.8 Model Version and Software Version

6.4.4. Daily Energy

The function is for checking the energy generation for a selected day.

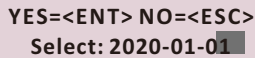

YES=<ENT> NO=<ESC>
Select: 2020-01-01

Figure 6.9 Select date for daily energy

Press DOWN key to move the cursor to day, month and year, press UP key to change the digit.

Press Enter after the date is fixed.

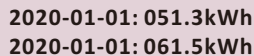

2020-01-01: 051.3kWh
2020-01-01: 061.5kWh

Figure 6.10 Daily energy

Press UP/DOWN key to move one date from another.

6.4.5. Monthly Energy

The function is for checking the energy generation for a selected month.

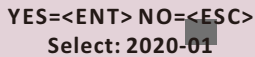

YES=<ENT> NO=<ESC>
Select: 2020-01

Figure 6.11 Select month for monthly energy

Press DOWN key to move the cursor to day and month, press UP key to change the digit.

Press Enter after the date is fixed.

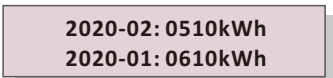

2020-02: 0510kWh
2020-01: 0610kWh

Figure 6.12 Month energy

Press UP/DOWN key to move one date from another.

6.4.6. Yearly Energy

The function is for checking the energy generation for selected year.

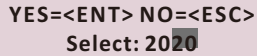

YES=<ENT> NO=<ESC>
Select: 2020

Figure 6.13 Select year for yearly energy

Press DOWN key to move the cursor to day and year, press UP key to change the digit. Press Enter after the date is fixed.

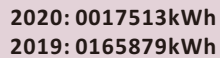

2020: 0017513kWh
2019: 0165879kWh

Figure 6.14 Yearly energy

Press UP/DOWN key to move one date from another.

6.4.7. Daily Record

The screen shows history of changing settings. Only for maintenance personnel.

6.4.8. Communication Data

The screen shows the internal data of the Inverter (see Figure 6.15), which is for service technicians only.

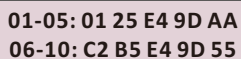

01-05: 01 25 E4 9D AA
06-10: C2 B5 E4 9D 55

Figure 6.15 Communication Data

6.4.9. Warning Message

The display shows the 100 latest warn messages (see Figure 6.16). Screens can be scrolled manually by pressing the UP/ DOWN keys. Press the ESC key to return to the previous menu.

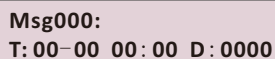

Msg000:
T: 00-00 00: 00 D: 0000

Figure 6.16 Warning Message

6.5 Advanced Settings - Technicians Only

Select Advanced Settings from the Main Menu to access the following options:

- 1. Select Standard
- 2. Grid ON/OFF
- 3. Clear Energy
- 4. Reset Password
- 5. Power Control
- 6. Calibrate Energy
- 7. Special settings
- 8. STD. Mode Settings
- 9. Restore settings
- 10. HMI Update
- 11. Internal EPM Set
- 12. Export Power Set
- 13. Restart HMI
- 14. Debug Parameter
- 15. DSP Update
- 16. Compensation Set



NOTE

This area is for fully qualified and accredited technicians only.
Please follow 6.4 to enter password to access this menu.

6.5.1 Selecting Standard

This function is used to select the grid's reference standard (see Figure 6.16).

YES=<ENT> NO=<ESC>
Standard:G59/3

Figure 6.16

Press the UP/DOWN keys to select the standard (UL-240V-A, UL-208V-A, UL-240V, UL-208V, R21P3-240, R21P3-208, ISONE240, ISONE208, R21P3-24A, R21P3-20A, ISONE240A, ISONE208A, MEX-CFE, User-Def, etc.). Press the ENTER key to confirm the setting. Press the ESC key to cancel changes and returns to previous menu.

There are 12 settings for USA and CSA market, UL-240V, UL-208V, R21P3-240, R21P3-208, ISONE240 and ISONE208 are the settings for inverters without AFCI Function. UL-240V-A, UL-208V-A, R21P3-24A, R21P3-20A, ISONE240A and ISONE208A are the settings for inverters with AFCI Function. The default grid setting is 240V.



NOTE

The default setting is 240V single phase “UL-240V” or “UL-240V-A”, Otherwise, refer to local requirements.



NOTE

This function is for technicians use only.

Selecting the “User-Def” menu will access to the following submenu (see Figure 6.17).

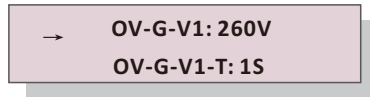

Figure 6.17



NOTE

The " User-Def" function can be only used by the service engineer and must be allowed by the providing utility.

Below is the setting range for “User-Def”. Using this function, the limits can be changed manually.

OV-G-V1: 220---300V	OV-G-F1: 50.2-53Hz(60.2-63Hz)
OV-G-V1-T: 0.1---9S	OV-G-F1-T: 0.1---90S
OV-G-V2: 220---300V	OV-G-F2: 51-53Hz(61-63Hz)
OV-G-V2-T: 0.1---1S	OV-G-F2-T: 0.1---9S
UN-G-V1: 110---210V	UN-G-F1: 47-49.5Hz(57-59.5Hz)
UN-G-V1-T: 0.1---9S	UN-G-F1-T: 0.1---9S
UN-G-V2: 110---210V	UN-G-F2: 47-49Hz(57-59Hz)
UN-G-V2-T: 0.1---1S	UN-G-F2-T: 0.1---9S
Startup-T: 10-600S	Restore-T: 10-600S

Table 6.2 Setting ranges for User-Def (L-N)

Press the UP/DOWN keys to scroll through items. Press the ENTER key to edit the highlighted item. Press the UP/DOWN keys again to change the setting. Press the ENTER key to save the setting. Press the ESC key to exit to save and send changes or cancel changes and return to the Advanced Settings Menu.

6.5.2 Grid ON/OFF

This function is used to start up or stop the power generation of Solis Single Phase Inverter.



Figure 6.18 Set Grid ON/OFF

Screens can be scrolled manually by pressing the UP/DOWN keys. Press the ENTER key to save the setting. Press the ESC key to return to the previous menu.

6.5.3 Clear Energy

Clear Energy can reset the history yield of the inverter.

6.5.4 Reset Password

This function is used to set the new password for menu “Advanced info.” and “Advanced information” (see Figure 6.19).

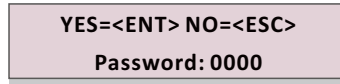

Figure 6.19 Set New Password

Enter the right password before set new password. Press the DOWN key to move the cursor, Press the UP key to revise the value. Press the ENTER key to execute the setting. Press the ESC key to return to the previous menu.

6.5.5 Power Control

This section is for setting the active and reactive power.

Within this section there are five functions:

1. Set output power
2. Set Reactive Power
3. Out_P With Restore
4. Rea_P With Restore
5. Select PF Curve

Functions 1-4 are used to set inverter output power and reactive power. With restore means the change will not revert to default after restart. The default setting for functions 1-4 are 100% for output power and 0 for reactive power.

Function 5 “select PF curve” will set a custom power factor curve for different grid standards. 00 is null. 01 is the PF Curve for VDE4105, 02 is the PF Curve for Brazil.

Other selections are reserved. The default setting is 00.



NOTE

This function is applicable by maintenance personnel only, wrong operation will prevent the inverter from reaching maximum power.

6.5.6 Calibrate Energy

Maintenance or replacement could clear or cause a different value of total energy.

Use this function to revise the value of total energy to the same value as before. If the monitoring website is used the data will be synchronize with this setting automatically.

YES=<ENT> NO=<ESC>

Energy:0000000kWh

Figure 6.20 Calibrate Energy

Press the DOWN key to move the cursor, Press the UP key to revise the value. Press the ENTER key to execute the setting. Press the ESC key to return to the previous menu.

6.5.7 Special Settings

There are 11 settings in this menu :

1. Grid Filter Set
2. Relay_protect Set
3. ILeak_Protect Set
4. GROUND_Protect Set
5. GRID INTF. 02 Set
6. MPPT Parallel Mode
7. Cnst. Voltage Mode
8. V/FRT Set
9. IgZero_COMP. Set
10. PI Set
11. IgADCheckPRO Set



NOTE

This function is for maintenance personnel only, wrong operation will prevent the inverter from reaching maximum power.

6.5.7.1 Grid Filter Set

Press the ENTER key to show the submenu of Grid Filter Set.

Press the UP/DOWN key to select the value.

Press the ENTER key to save the setting and return to the previous menu.



NOTE

This function is applicable by maintenance personnel only, wrong operation will prevent the inverter from reaching maximum power.

6.5.7.2 Relay_Protect Set



NOTE

This function is for maintenance personnel only, wrong operation could disable inverter important function.

6.5.7.3 ILeak_Protect Set



NOTE

This function is for maintenance personnel only, wrong operation could disable inverter important function.

6.5.7.4 GROUND_Protect Set



NOTE

This function is for maintenance personnel only, wrong operation could disable inverter important function.

6.5.7.5 GRID INTF.02 Set



NOTE

This function is for maintenance personnel only, wrong operation will prevent the inverter from reaching maximum power.

6.5.7.6 MPPT Parallel Mode

This is used for parallel strings into different inverter MPPTs.

Press enter and press up or down to change the settings(see Figure 6.21).

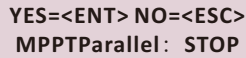

```
YES=<ENT> NO=<ESC>
MPPTParallel: STOP
```

Figure 6.21 MPPT Parallel Set

Selecting RUN will enable parallel strings setup. Both MPPT channels will operate in parallel. Selecting STOP disables parallel string setup. Both MPPT channels will operate separately. The default setting is STOP (disabled).



NOTE

This function is for maintenance personnel only, wrong operation will prevent the inverter from reaching maximum power.

6.5.7.7 Cnst. Voltage Mode

This function is used for fixed input voltage(see Figure 6.22).



```
CV Mode: STOP
Voltage: 600V
```

Figure 6.22 Cnst. Voltage Set

Selecting RUN will enable fixed input voltage. The inverter will not operate if the input voltage is lower than the set voltage. Selecting STOP will disable this function. The default setting is STOP (disabled).



NOTE

This function is for maintenance personnel only, wrong operation will prevent the inverter from reaching maximum power.

6.5.7.8 V/FRT Set

There are 5 option under this setting:

The function **VRT_US** (voltage ride through) and **FRT_US** (frequency ride through) are used for UL1741SA (see Table 6.2, Table 6.3).

Selecting the setting to RUN will enable the inverter grid protection limits of UL 1741 SA requirements. Selecting the STOP setting will enable the inverter grid protection limits of IEEE 1547 requirements. The default setting is STOP.



NOTE

.LVRT_CQC 2.LVRT.GN 3.LVRT-BAR are not used for the US ,

Region	System Frequency Default Settings	Minimum Range of Adjustability (HZ)	Ride-through until	Ride-Through Operational Mode	Trip Time	Remarks
1	f 62	62.0-64.0	//	Not Applicable	0.16S	//
2	60.5 fs62	60.1-62.0	299S	Mandatory Operation	300S	Enter protected state
3	58.5 fs60.5	//	//	Continuous Operation	//	//
4	57.0 fs58.5	57.0-59.9	299S	Mandatory Operation	300S	Enter protected state
5	fs57.0	53.7-57.0	//	Not Applicable	0.16S	//

Table 6.3 Frequency ride through

Wear pressure	Region	voltage % nominal voltage		Ride-through until	Operating mode	Maximum time limit
		240Va.c.	208Va.c.			
1	Hv2	V≥288	V≥249.6	//	Not Applicable	0.16S
2	Hv1	264 V 288	228.8 V 249.6	12S	Momentary Cessation	13S
3	NN	211.2≤V≤264	183.04≤V≤228.8	//	Continuous Operation	//
4	Lv1	168≤V 211.2	145.6≤V 183.04	20S	Mandatory Operation	21S
5	Lv2	120≤V 168	104≤V 145.6	10S	Mandatory Operation	11S
6	Lv3	V 120	V 104	1S	Momentary Cessation	1. 5S

Table 6.4 Voltage ride through

The voltage and frequency ride through limit is fixed.

VRT_US : STOP

FRT_US : STOP

Figure 6.23 V/FRT Set

6.5.7.9 IgZero_COMP.Set



NOTE

This function is for maintenance personnel only, wrong operation will prevent the inverter from reaching maximum power.

6.5.7.10 PI Set



NOTE

This function is for maintenance personnel only, wrong operation will prevent the inverter from reaching maximum power.

6.5.7.11 IgADCheckPRO Set



NOTE

This function is for maintenance personnel only, wrong operation will prevent the inverter from reaching maximum power.

6.5.8 STD. Mode Settings

Selecting “STD Mode. Settings” displays the sub-menu shown below:

1. Working Mode Set
2. Power Rate Limit
3. Freq Derate Set
4. 10mins Voltage Set
5. Power Priority
6. Initial Settings
7. Voltage PCC Set
8. Freq-Watt

6.5.8.1 Working Mode Set

There are TWO situations with different grid standards selected.

6.5.8.1.1 With UL Standard selected



NOTE

The following modes are for "UL-240V", "UL-240V-A".

Solis US version inverters have Seven working modes:

1. NULL
2. Volt-watt
3. Volt-Var
4. Fixed-PF
5. Reac-power
6. Power-PF
7. VgWatt-UL

Based on UL1741SA, working mode 1,3,4,7 can be used by grid operator.

1.NULL

Description: Inverter is not under any working mode.

2. Volt-Watt (Not Required)

Description: Inverter will change the active output power based on voltage change.

Note: This Setting is NOT required by UL1741SA Standards.



NOTE

This function is for maintenance personnel only, wrong operation will prevent the inverter from reaching maximum power.

3. Volt-Var (Default)

Description: Inverter will change the reactive output power based on voltage change.

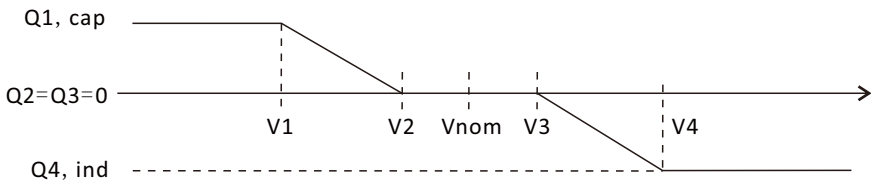

Figure 6.24 Volt-Var curve for Q (V)

Default Settings for UL1741SA:

Q1: (0-60%) Default +30% Q4: (-60%-0%) Default -30%

Rated 240V Grid

V1:(192-240V) Default 210V V2: (192-240V) Default 236V

V3:(240-288V) Default 243V V4: (240-288V) Default 264V

Rated 208V Grid

V1:(166-208V) Default 182V V2: (166-208V) Default 205V

V3:(208-240V) Default 211V V4: (208-240V) Default 229V

Voltage1 : 210V
Voltage2 : 236V

Figure 6.25 Volt-VAR

4.Fixed-PF

Description: Inverter will output power with fixed power factor.

Setting Range: -0.8 to +0.8

Default value is PF = 1

YES=<ENT> NO=<ESC>
Power Factor : +1.00

Figure 6.26 Fixed-PF

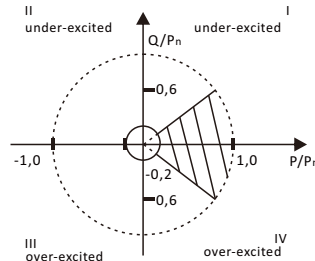

Figure 6.27 PF Range

5. Reac-Power (Not Required)

Description: Inverter will generate reactive power based on changing output power.

Note: This Setting is NOT required by UL1741SA Standards.



NOTE

This function is for maintenance personnel only, wrong operation will prevent the inverter from reaching maximum power.

6. P-Factor (Not Required)

Description: Inverter will change power factor based on changing output power.

Note: This Setting is NOT required by UL1741SA Standards.



NOTE

This function is for maintenance personnel only, wrong operation will prevent the inverter from reaching maximum power.

7.VgWatt-UL

Description: Inverter will change the active output power based on voltage change.

Note: This is the Volt-Watt Setting for UL1741SA Standards.

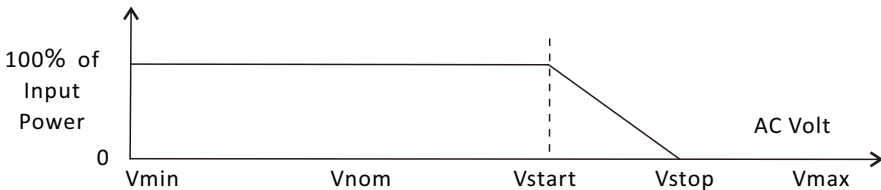

Figure 6.28 Volt-Watt characteristic

Default Settings for UL1741SA:

Rated 240V Grid

V1:less than V2

V2:less than Vstart

V3 (Vstart): (240-288V) Default264V

V4 (Vstop): (264-312V) Default 288V

P1:100% P2:100% P3: 100% P4:0%

Rated 208V Grid

V1:less than V2

V2:less than Vstart

V3 (Vstart): (208-250V) Default229V

V4 (Vstop): (229-270V) Default 250V

P1:100% P2:100% P3: 100% P4:0%

Voltage1 : 210V

Voltage2 : 236V

Figure 6.29 Vgwatt-UL

6.5.8.1.2 With Rule21 Standard selected



NOTE

The following modes are for "R21P3-480", "R21P3-48A".

Solis US version inverters have Ten working modes:

- 1.NULL
- 2.Volt-watt
- 3.Volt-Var
- 4.Fixed-PF
- 5.Reac-power
- 6.Power-PF
- 7.VgWatt-UL

Based on Rule21, working mode 1,2,3,4 can be used by grid operator.



NOTE

The other three working mode "P1-V-Watt", "P1-V-Var" and "P1-V-P&V-Q" are NOT applicable for settings.

1.NULL (Mode Reset)

Description: Inverter is not under any working mode.

2. Volt-Watt

Description: Inverter will change the active output power based on voltage change.

Note: This is the Volt-Watt Setting for Rule21 Standards.

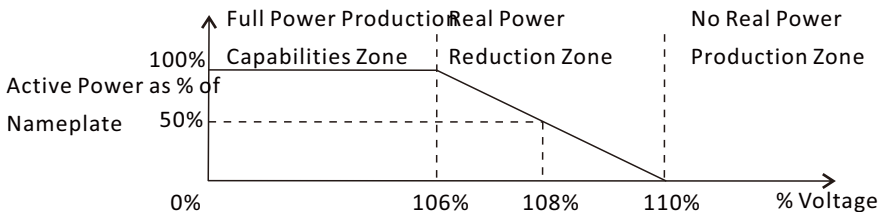

Figure 6.30 Volt-Watt characteristic

Default Settings for Rule21 Standards:

- Rated 240V Grid
- V1: less than Vstart
- V2 (Vstart): (240-288V) Default 254V
- V3 (Vstop): (240-288V) Default 264V
- V4: larger than Vstop
- P1:100% P2:100% P3: 0% P4:0%

3. Volt-Var

Description: Inverter will change the reactive output power based on voltage change.

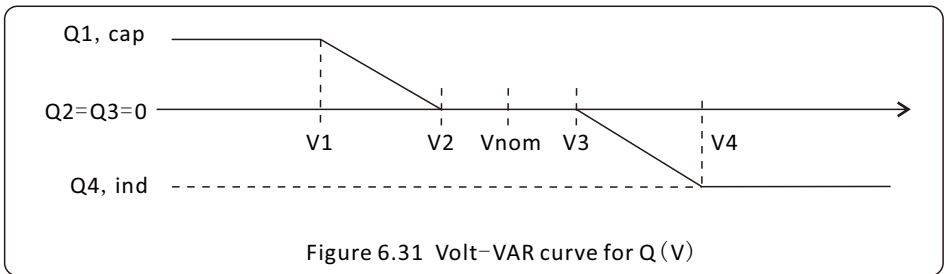

Default Settings for Rule21 Standard:

Q1: (0-60%) Default +30% Q4: (-60%-0%) Default -30%

Rated 240V Grid

V1:(192-264V) Default 220V V2: (192-264V) Default 232V
 V3:(240-288V) Default 248V V4: (240-288V) Default 256V

Rated 208V Grid

V1:(166-229V) Default 191V V2: (166-229V) Default 201V
 V3:(208-250V) Default 215V V4: (208-250V) Default 223V

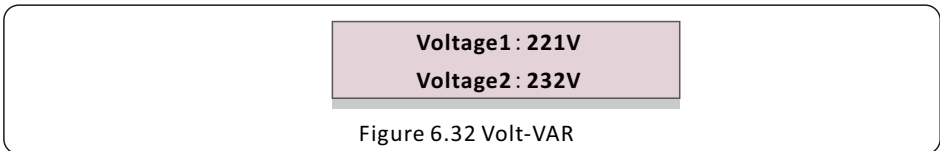

4.Fixed-PF

Description: Inverter will output power with fixed power factor.

Setting Range: -0.8 to +0.8

Default value is PF = 1

YES=<ENT> NO=<ESC>
Power Factor: +1.00

Figure 6.33 Fixed-PF

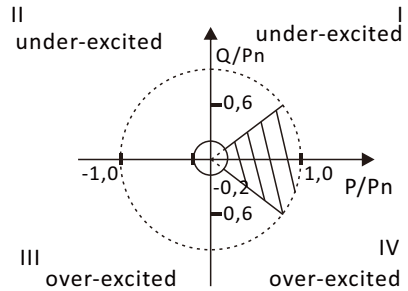

Figure 6.34 PF Range

5. Reac-Power (Not Required)

Description: Inverter will generate reactive power based on changing output power.

Note: This Setting is NOT required by Rule21 Standards.



NOTE

This Setting is NOT required by Rule21 Standards.



NOTE

This function is for maintenance personnel only, wrong operation will prevent the inverter from reaching maximum power.

6. P-Factor (Not Required)

Description: Inverter will change power factor based on changing output power.

Note: This Setting is NOT required by Rule21 Standards.



NOTE

This function is for maintenance personnel only, wrong operation will prevent the inverter from reaching maximum power.

7.VgWatt-UL (Not Required)

Description: Inverter will change the active output power based on voltage change.

Note: This Setting is NOT required by Rule21 Standards.



NOTE

This function is for maintenance personnel only, wrong operation will prevent the inverter from reaching maximum power.

8. Enable both Volt-Var and Volt-Watt modes

Description: Rule21 requires both Volt-var and Volt-watt modes can be enabled.

To set both modes (Volt-var in high priority)

Step 1: Select and set Volt-watt mode at first.

Step 2: Enter "Working Mode" again and select and set Volt-var mode then.

Step 3: To check the priority, a new mode will appear as "V-Q & V-P" which indicates (Q) Volt-var is in high priority.

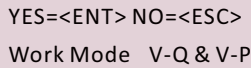

```
YES=<ENT> NO=<ESC>  
Work Mode V-Q & V-P
```

Figure 6.35 Work Mode

To set both modes (Volt-watt in high priority)

Step 1: Select and set Volt-var mode at first.

Step 2: Enter "Working Mode" again and select and set Volt-watt mode then.

Step 3: To check the priority, a new mode will appear as "V-P & V-Q" which indicates (P) Volt-watt is in high priority.

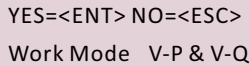

```
YES=<ENT> NO=<ESC>  
Work Mode V-P & V-Q
```

Figure 6.36 Work Mode

To reset dual-mode or exit the dual-mode situation

Step 1: Select "Null" mode at first.

Step 2: Enter "Working Mode" again. Redo above dual-mode setting steps to reset OR set other modes to exit dual-mode situation.



NOTE

To check the Volt-watt and Volt-var priority, simply enter the working modes.

V-Q&V-P indicates Volt-Var First V-P&V-Q indicates Volt-Watt First

6.5.8.2 Power Rate Limit

This function is used for changing power ramp up rate.

When the inverter initializes or string MPPT changes, the ramp up rate is limited.

The default setting is stop (disable).

The setting range is from 10% to 600%, This will change the power change rate per minute. If these values are changed the inverter may not conform to UL 1741 SA or IEEE 1547 standard.

Power Rate:016%
RateP_Sts-US:STOP

Figure 6.37 Power Rate Limit

6.5.8.3 Freq Derate Set

This setting is applicable when UL Standards are selected.

There are five frequency derate modes in this menu when UL-208/240 grid standard is selected. Modes 00 – 03 are disabled. Mode 04 is used for UL 1741 SA frequency derating settings. Within this mode the user can set the frequency start and stop points.

The default setting is 00(disabled).

Derate Mode : 04
OV-F-Start : 60. 20Hz

Figure 6.38 Freq Derate Set

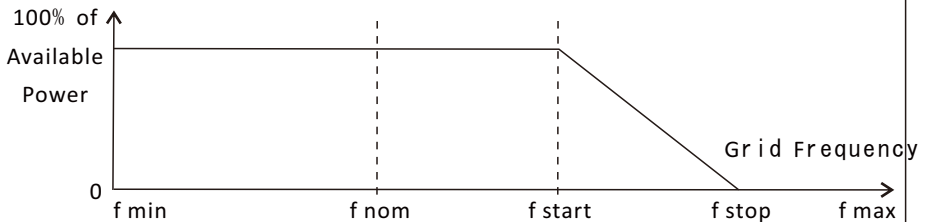

Figure 6.39 Freq-Watt characteristic

Over frequency load shedding F start range is 59.936-60.036Hz.

The default setting is 60.036Hz.

Descending rate: 5%Pn/0.1Hz.

F stop range: 61-64Hz. Default setting is 62Hz. Recovery rate: 5%Pn/0.1Hz.

Press the Enter key to select the mode or frequency.

Press Up/ Down to set. Press ESC to save the settings.

6.5.8.4 10mins Voltage Set

This function is disabled and not used for the US.



NOTE

This function is for maintenance personnel only, wrong operation will prevent the inverter from reaching maximum power.

6.5.8.5 Power Priority

This setting is used to determine the priority between Active Power Control (Watt) and Reactive Power Control (Var).

YES=<ENT> NO=<ESC>
Select: Var First

Figure 6.40 Power Priority

Two options are available: Watt First and Var First.

This setting determines the priority when both Volt-Watt and Volt-Var modes are enabled.



NOTE

This function is for maintenance personnel only, wrong operation will prevent the inverter from reaching maximum power.

6.5.8.6 Initial Settings

This setting will allow the working modes from 6.5.8.1 to 6.5.8.4 to be set back to default.

Work Mode Default
Power Rate Default

Figure 6.41 Initial Settings

6.5.8.7 Voltage PCC Set

Set the voltage at the PCC point. This setting is required by RULE 21 requirements.

PCC: Point of Common Coupling, the point where a Local EPS is connected to an Area EPS.



NOTE

This function is for maintenance personnel only, wrong operation will prevent the inverter from reaching maximum power.

6.5.8.8 Freq-Watt

This setting is used to control real power based on the frequency excursion

This setting is applicable when Rule21 Standards are selected.



Figure 6.42 Freq-Watt (1)

Start Freq: This is the frequency that active power reduction starts.

WGradient: This is the active power reduction rate in terms of the frequency.

Stop Freq: This is the frequency that stops the correction cycle.

Hysteresis: This indicates whether hysteresis is enabled.

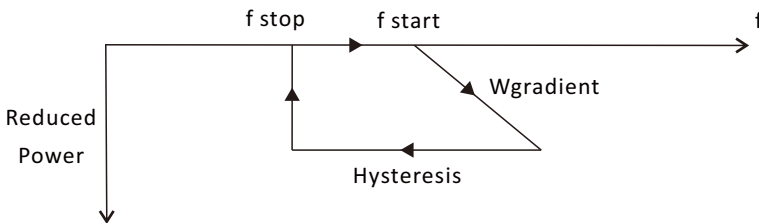

Figure 6.43 Freq-Watt (2)



NOTE

This function is for maintenance personnel only, wrong operation will prevent the inverter from reaching maximum power.

6.5.9 Restore Settings

Restore settings will set all items in 6.5.7 special settings to default.

The screen shows as below:

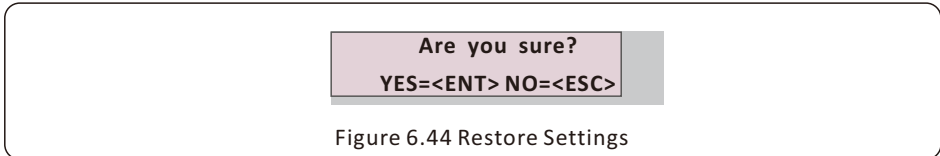

Figure 6.44 Restore Settings

Press the Enter key to save the setting after setting grid off.

Press the ESC key to return the previous mean.

6.5.10 HMI Update

This function is used for update the LCD program.



NOTE

This function is for maintenance personnel only, wrong operation will prevent the inverter from reaching maximum power.

6.5.11 Internal EPM Set

Select EPM Settings from the Main Menu to access the following options:

1. **Mode Select**
2. **Set Backflow Power**
3. **Fail safe ON/OFF**

6.5.11.1 Mode Select

There are 3 settings in this menu as below:

1. **EPM OFF**
2. **Meter in Load**
3. **Meter in Grid**

EPM OFF: Functions are disabled

Meter in Load: Solis Smart Meter is connected in the load branch circuit.

Meter in Grid: Solis Smart Meter is connected in the grid connection point
(The backflow power is default as 0W).

6.5.11.2 Backflow Power

The setting is used to define the allowed export power into the grid.

->Set Backflow Power

YES=<ENT> NO=<ESC>
Power:-00000W

Figure 6.45 Set the backflow power



NOTE

Positive values indicate the amount of power is allowed to export to the grid.

Negative values indicate a more strict control to limit the export power in advance thus ensuring exact no power is feeding into the grid.

6.5.11.3 Fail safe ON/OFF

This setting is used to give out an alarm (stop inverter generation as well) when the CT/Meter connection is lost during operation.

It can prevent potential backflow power into the grid when the system loses control.

YES=<ENT> NO=<ESC>
Fail Safe Set:ON

Figure 6.46 Set the Fail Safe ON/OFF

It is only mandatory to turn on this function when the inverter is installed in UK due to the G100 regulation. For other regions, customers can enable or disable the function as they desire.



NOTE

When the fail safe function is ON and CT/Meter is disconnected somehow, the inverter will stop generation and give "Failsafe" alarm on the LCD.

When the failsafe function is OFF and CT/Meter is disconnected somehow, the inverter will keep the output power as the last moment when the CT/Meter is still connected. After a restart, the inverter will output at full power without limit.

6.5.12 External EPM Set

This setting should only be turned on when Solis external EPM device is used.

Two options are available 5G-EPM and Others-EPM.

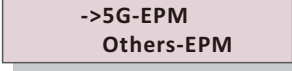

->5G-EPM
Others-EPM

Figure 6.47

5G-EPM Failsafe Option should be turned ON when 5G series EPM device is used

Others-EPM Failsafe Option should be turned ON when 2G series EPM device is used

Only one option can be activated each time.

6.5.13 Restart HMI

The function is used for restart the HMI.



NOTE

This function is for maintenance personnel only, wrong operation will prevent the inverter from reaching maximum power.

6.5.14 Debug Parameter

This function is used for manufacturer maintenance personnel only.

6.5.15 DSP Update

The function is used for update the DSP.



NOTE

This function is for maintenance personnel only, wrong operation will prevent the inverter from reaching maximum power.

6.5.16 Compensation Set

This function is used to calibrate inverter output energy and voltage. It will not impact the energy count for inverter with RGM.

Two sections are included: Power Parameter and Voltage Parameter.

The screen shows:

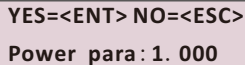

YES=<ENT> NO=<ESC>
Power para: 1. 000

Figure 6.48 Power Rate Limit

Press the Down key to move the cursor.

Press the Up key to change the digit.

Please press the Enter to save the setting and press the ESC key to return to the previous menu.



NOTE

This setting is used for grid operators, do not change this setting unless specifically instructed to.

6.6 Arc fault (AFCI version)

Solis single phase inverters have a built-in AFCI function which can detect an arc fault within the DC circuit. If the arc fault happens, it can only be removed manually.

During normal operation, if arc fault happens in the DC circuit, the inverter will stop output and the LCD will show:



ARC-FAULT
Restart Press ESC 3s

Figure 6.49 Arc Fault

Please check DC cables and connections to identify the source of possible arcing. Then **press <ESC> for 3 seconds**, the inverter will restart.

Solis single phase inverter does not require any regular maintenance. However, cleaning the dust on the heat sink will help the inverter to dissipate heat and increase its life expectancy. The dust can be removed with a soft brush.



CAUTION

Do not touch the inverter's surface when it is operating. Some parts of the inverter may be hot and cause burns. Turn off the inverter (refer to Section 5.2) and wait for a cool-down period before any maintenance or cleaning operation.

The LCD and the LED status indicator lights can be cleaned with a damp cloth if they are too dirty to be read.



NOTE

Never use any solvents, abrasives or corrosive materials to clean the inverter.

The inverter is designed in accordance with the most important international grid-tied standards and safety and electromagnetic compatibility requirements. Before delivering to the customer, the inverter has been subjected to several tests to ensure its optimal operation and reliability.

In case of failure, the LCD screen will display an alarm message. In this case, the inverter may stop feeding into the grid. The failure descriptions and their corresponding alarm messages are listed in Table 8.1:

Alarms	Cause	Solution
No Information (Blank Screen)	<ul style="list-style-type: none"> • Input voltage low/missing • Polarity reversed • Main board damaged 	<p>Test – DC switch OFF</p> <ul style="list-style-type: none"> • Check PV connections • Check polarity • Check voltage >120V Single, >350V three <p>Test – DC Switch ON</p> <ul style="list-style-type: none"> • Check voltage >120V Single, >350V three • If DC voltage is “0” replace inverter
Initializing (Inverter stuck in this mode)	<ul style="list-style-type: none"> • Inverter is waiting for driving signal 	<p>Test – DC switch OFF</p> <ul style="list-style-type: none"> • Check PV connections • Check polarity • Check voltage >120V Single, >350V three <p>Test – DC Switch ON</p> <ul style="list-style-type: none"> • Check voltage >120V Single, >350V three • A cable may have been damaged or loosened in shipping replace inverter
OV-G-V: Over Grid Voltage	<ul style="list-style-type: none"> • Inverter detects grid voltage as too high 	<p>Test – DC switch OFF</p> <ul style="list-style-type: none"> • Check AC at the inverter • If AC measures high, adjust upper limit with permission from utility <p>Test – DC Switch ON, full power</p> <ul style="list-style-type: none"> • Check AC at inverter test points • Compare with LCD • If AC measures high, cables between inverter and interconnect are too small • Check ampacity and voltage drop calculations • Verify appropriate Grid Standard

Alarms	Cause	Solution
UN-G-V: Under Grid Voltage	<ul style="list-style-type: none"> • Inverter detects grid voltage as too low 	<p>Test – DC switch OFF</p> <ul style="list-style-type: none"> • Check AC at the inverter test points • If AC measures low, adjust lower limit with permission from utility • Check LCD voltage reading, may be a bad measurement circuit <p>Test – DC Switch ON</p> <ul style="list-style-type: none"> • Verify appropriate Grid Standard • Replace inverter
OV-G-F: Over Grid Frequency	<ul style="list-style-type: none"> • Inverter detects grid Frequency as too high 	<p>Test – DC switch OFF</p> <ul style="list-style-type: none"> • Check frequency at the inverter test points • If Frequency measures high, adjust upper limit with permission from utility • Check LCD reading, may be a bad measurement circuit <p>Test – DC Switch ON</p> <ul style="list-style-type: none"> • Verify appropriate Grid Standard • Replace inverter
UN-G-F: Under Grid Frequency	<ul style="list-style-type: none"> • Inverter detects grid Frequency as too low 	<p>Test – DC switch OFF</p> <ul style="list-style-type: none"> • Check frequency at the inverter test points • If Frequency measures low, adjust lower limit with permission from utility • Check LCD reading, may be a bad measurement circuit <p>Test – DC Switch ON</p> <ul style="list-style-type: none"> • Verify appropriate Grid Standard • Replace inverter
NO-GRID	<ul style="list-style-type: none"> • Inverter does not detect the grid 	<p>Test – DC switch OFF</p> <ul style="list-style-type: none"> • Check AC at the inverter test points • L-L, L-GND • Do NOT tell me 240VAC • Check LCD reading, may be a bad measurement circuit <p>Test – DC Switch ON</p> <ul style="list-style-type: none"> • Check grid standard • Replace inverter
OV-DC: DC voltage is too high	<ul style="list-style-type: none"> • Inverter detects High DCV 	<p>Test – DC switch OFF</p> <ul style="list-style-type: none"> • Check DC at the inverter test points • If DCV is high, too many panels in the string <p>Test – DC Switch ON</p> <ul style="list-style-type: none"> • Check LCD reading, may be a bad measurement circuit • Replace inverter

Alarms	Cause	Solution
OV-BUS: DC BUS voltage is too high	<ul style="list-style-type: none"> Inverter detects High DCV on internal bus 	Test <ul style="list-style-type: none"> Measure DC and AC voltages Compare with LCD Replace inverter Internal damage Wire came loose during shipping
UN-BUS: DC BUS voltage is too low	<ul style="list-style-type: none"> Inverter detects low DCV on internal bus 	Test <ul style="list-style-type: none"> Measure DC and AC voltages Compare with LCD Replace inverter Internal damage Wire came loose during shipping
GRID-INTF: Grid unstable	<ul style="list-style-type: none"> Inverter detects grid instability, internal fault current high 	Test – With DC Switch OFF <ul style="list-style-type: none"> Measure AC voltage Test AC line for THD Test – With DC Switch ON <ul style="list-style-type: none"> Test AC line for THD Multiple inverters/turn one off Impedance matching adjustment or box Internal damage Wire came loose in shipping
INI-FAULT: Initialization Protection	<ul style="list-style-type: none"> Master and Slave DSP have different values 	Reset Inverter <ul style="list-style-type: none"> DC switch OFF Wait until all lights/LCD turn off DC switch ON Replace inverter
OV-TEM: Temperature Protection	<ul style="list-style-type: none"> Inverter detects high ambient temperature >60C 	Inspect installation <ul style="list-style-type: none"> Check heatsink for obstructions/ventilation Is inverter in direct sunshine Measure ambient temperature near inverter If temp is in range replace inverter
PV ISO-PRO 01/02: Ground Protection	<ul style="list-style-type: none"> Inverter detects low DC insulation resistance 	Inspect installation <ul style="list-style-type: none"> Reset inverter Note weather conditions when alarm occurs Measure insulation resistance If normal, measure in SAME weather as alarm Physically check cables Replace inverter

Alarms	Cause	Solution
AFCI Check FAULT	<ul style="list-style-type: none"> • AFCI module self check fault 	Reset Inverter <ul style="list-style-type: none"> • DC switch OFF • Wait until all lights/LCD turn off • DC switch ON • Replace inverter
ARC-FAULT	<ul style="list-style-type: none"> • Inverter detects arc in DC circuit 	Inspect installation <ul style="list-style-type: none"> • Check cable with string tester • Physically check cables • Inspect panel junction boxes • Inspect cable connections • Reset inverter • Replace inverter
Screen OFF with DC applied	<ul style="list-style-type: none"> • Inverter internally damaged 	<ul style="list-style-type: none"> • Do not turn off the DC switches as it will damage the inverter. • Please wait for the solar irradiance reduces and confirm the string current is less than 0.5A with a clip-on ammeter and then turn off the DC switches. • Please note that any damages due to wrong operations are not covered in the device warranty.

Table 8.1 Fault messages and descriptions



NOTE

If the inverter displays any alarm message as listed in Table 8.1; please turn off the inverter (refer to Section 5.2 to stop your inverter) and wait for 5 minutes before restarting it (refer to Section 5.1 to start your inverter). If the failure persists, please contact your local distributor or the service center. Please keep ready with you the following information before contacting us.

1. Serial number of Solis Single Phase Inverter;
2. The distributor/dealer of Solis Single Phase Inverter (if available);
3. Installation date.
4. The description of problem (i.e. the alarm message displayed on the LCD and the status of the LED status indicator lights. Other readings obtained from the Information submenu (refer to Section 6.2) will also be helpful.);
5. The PV array configuration (e.g. number of panels, capacity of panels, number of strings, etc.);
6. Your contact details.

Solis US Technical Support Phone Number: +1(866)438-8408

Solis US Technical Support email: usservice@solisinverters.com

9. Specifications

Model	Solis-1P3.6K-4G-US
Max. input voltage	600V
Rated voltage	330V
Start-up voltage	120V
MPPT voltage range	90-520V
Full load MPPT voltage range	169-520V
Max. input current	14A/14A
Max. short circuit current	22A/22A
MPPT number / Max. input strings number	2/2
Rated output power	3.6kW
Max. apparent output power	3.6kVA
Max. output power	3.6kW
Rated grid voltage	1Φ/PE, 240 V / 208 V
Grid voltage range	211-264 V (for 240 V rated) / 183-228 V (for 208 V rated)
Grid frequency	60 Hz
Grid frequency range	59.5-60.5 Hz
Max. output current for 240V grid	15 A
Max. output current for 208V grid	17.3A
Power Factor	> 0.99 (0.8 leading - 0.8 lagging)
THDi	<3%
DC injection current	<0.5% In
Max. efficiency	97.3%
CEC efficiency	96.6%
MPPT efficiency	99.5%
DC reverse-polarity protection	Yes
Ground fault monitoring	Yes
Anti-islanding protection	Yes
Integrated AFCI (DC arc-fault circuit protection)	Yes
Sunspec PLC signal for rapid shutdown	Yes
Dimensins (W*H*D)	13.9*31.9*6.5in (352*810*164mm)
Weight	33.1lb (15kg)
Topology	Transformerless
Self consumption (Night)	<1 W
Relative humidity	0-100%
Operating ambient temperature range	-13 °F ~ 140 °F (-25 °C ~ 60 °C)
Storage environment	-13 °F ~ 176 °F (-25 °C ~ 80 °C)
Ingress protection	TYPE 4X

9. Specifications

Model	Solis-1P3.6K-4G-US
Cooling concept	Natural convection
Max. operating altitude	13120 ft (4000 m)
Compliance	UL1741SB, UL1741SA, IEEE 1547-2018, UL1699B, UL1998, FCC Part15 ClassB, California Rule 21, Heco Rule 14H (pending) NEC 690.12-2020, CAN/CSA C22.2107.1-1.
DC connection	1 knockout for 3/4" conduit at bottom, side and back, , Screw clamp terminal
AC connection	1 knockout for 3/4" conduit at bottom, side and back, OT terminal
Display	LCD
Commiunication	Rs485, Optional: Cellular, Wi-Fi
Warranty	10 years (Extend to 20 years)

9. Specifications

Model	Solis-1P5K-4G-US
Max. input voltage	600V
Rated voltage	330V
Start-up voltage	120V
MPPT voltage range	90-520V
Full load MPPT voltage range	228-520V
Max. input current	14A/14A
Max. short circuit current	22A/22A
MPPT number / Max. input strings number	2/2
Rated output power	5kW
Max. apparent output power	5kVA
Max. output power	5kW
Rated grid voltage	1Φ/PE, 240 V / 208 V
Grid voltage range	211-264 V (for 240 V rated) / 183-228 V (for 208 V rated)
Grid frequency	60 Hz
Grid frequency range	59.5-60.5 Hz
Max. output current for 240V grid	20.8A
Max. output current for 208V grid	24.0A
Power Factor	> 0.99 (0.8 leading - 0.8 lagging)
THDi	<3%
DC injection current	<0.5% In
Max. efficiency	97.7%
CEC efficiency	97.1%
MPPT efficiency	99.5%
DC reverse-polarity protection	Yes
Ground fault monitoring	Yes
Anti-islanding protection	Yes
Integrated AFCI (DC arc-fault circuit protection)	Yes
Sunspec PLC signal for rapid shutdown	Yes
Dimensins (W*H*D)	13.9*31.9*6.5in (352*810*164mm)
Weight	33.1lb (15kg)
Topology	Transformerless
Self consumption (Night)	<1 W
Relative humidity	0-100%
Operating ambient temperature range	-13 °F ~ 140 °F (-25 °C ~ 60 °C)
Storage environment	-13 °F ~ 176 °F (-25 °C ~ 80 °C)
Ingress protection	TYPE 4X

9. Specifications

Model	Solis-1P5K-4G-US
Cooling concept	Natural convection
Max. operating altitude	13120 ft (4000 m)
Compliance	UL1741SB, UL1741SA, IEEE 1547-2018, UL1699B, UL1998, FCC Part15 ClassB, California Rule 21, Heco Rule 14H (pending) NEC 690.12-2020, CAN/CSA C22.2107.1-1.
DC connection	1 knockout for 3/4" conduit at bottom, side and back, Screw clamp terminal
AC connection	1 knockout for 3/4" conduit at bottom, side and back, OT terminal
Display	LCD
Communication	Rs485, Optional: Cellular, Wi-Fi
Warranty	10 years (Extend to 20 years)

Manufacturer: Ginlong Technologies Co.,Ltd., Ningbo, Zhejiang, P.R.China

US Office: 565 Metro Pl. S. Suite 3214, Dublin OH 43017, USA

Toll-free: 866.438.8408 | Email: sales@ginlong.com | ussales@ginlong.com

Web: www.ginlong.com

Please adhere to the actual products in case of any discrepancies in this user manual.



**SunSpec
Certified**



**Comply with CA Rule 21/
Certified to UL 1741 SA and SB**