



User Manual

for S6 Series Hybrid Inverter



Applicable models
S6-EH1P3K-L-PLUS
S6-EH1P3.6K-L-PLUS
S6-EH1P5K-L-PLUS
S6-EH1P6K-L-PLUS
S6-EH1P8K-L-PLUS

Applicable System
Single phase system

Important Notes

- Due to the product development, the product specifications and functions are subject to change. The latest manual can be acquired via <https://www.ginlong.com/global>. Every attempt has been made to make this document complete, accurate and up-to-date. Individuals reviewing this document and installers or service personnel are cautioned, however, that Solis reserves the right to make changes without notice and shall not be responsible for any damages, including indirect, incidental or consequential damages caused by reliance on the material presented including, but not limited to, omissions, typographical errors, arithmetical errors or listing errors in the material provided in this document.
- Solis accepts no liability for customers' failure to comply with the instructions for correct installation and will not be held responsible for upstream or downstream systems Solis equipment has supplied.
- The customer is fully liable for any modifications made to the system; therefore, any hardware or software modification, manipulation, or alteration not expressly approved by the manufacturer shall result in the immediate cancellation of the warranty.
- Given the countless possible system configurations and installation environments, it is essential to verify adherence to the following:
 - There is sufficient space suitable for housing the equipment.
 - Airborne noise produced depending on the environment.
 - Potential flammability hazards.
 - Solis will not be held liable for defects or malfunctions arising from:
 - Improper use of the equipment.
 - Deterioration resulting from transportation or particular environmental conditions.
 - Performing maintenance incorrectly or not at all.
 - Tampering or unsafe repairs.
 - Use or installation by unqualified persons.
 - This product contains lethal voltages and should be installed by qualified electrical or service personnel having experience with lethal voltages.

1. Introduction	01-04
1.1 Product Overview	01
1.2 Inverter Wire Box and Connection Points	02
1.3 Product Features	03
1.4 Packaging	04
1.5 Tools Required for Installation	04
2. Safety & Warning	05-07
2.1 Safety	05
2.2 General Safety Instructions	05
2.3 Notice for Use	07
2.4 Notice for Disposal	07
3. Installation	08-32
3.1 Select a Location to Install the Inverter	08
3.2 Product Handling	10
3.3 Mounting the Inverter	11
3.4 Inverter Wiring Overview	13
3.5 Ground Cable Installation	14
3.6 PV Cable Installation	15
3.7 Battery Cable Installation	18
3.8 AC Wiring	19
3.9 Meter/CT Connection	20
3.10 Inverter Communication	22
3.11 Diesel Generator Wiring	30
3.12 Parallel System Wiring	31
3.13 Inverter Remote Monitoring Connection	33
4. Overview	34-35
4.1 Intelligent LED Indicators	34
4.2 Password Reset	35
4.3 Inverter built-in Bluetooth description	35
5. Commissioning	36-42
5.1 Pre-Commissioning	36
5.2 Power ON	36
5.3 Power OFF	36
5.4 Log in the APP via Bluetooth	37
5.5 Initial set up	38
5.6 APP Interface	42
6. Maintenance	50
6.1 Smart O&M	50
7. Troubleshooting	51
8. Specifications	56
9. Appendix - FAQs	65

1.1 Product Overview

The Solis S6-EH1P(3-8)K-L-PLUS series is designed for residential hybrid systems. The inverter can work with low-voltage lithium ion and Lead-acid batteries to maximize self-consumption and provide backup power if the grid fails and there is not enough PV power to cover load demand.

The S6-EH1P(3-8)K-L-PLUS series consists of the following inverter models: 3kW, 3.6kW, 5kW, 6kW, 8kW

The 8K model is of different hardware and size from the 3-6K models.

The max.input strings number of 8K is 3, and the 3-6K is 2.

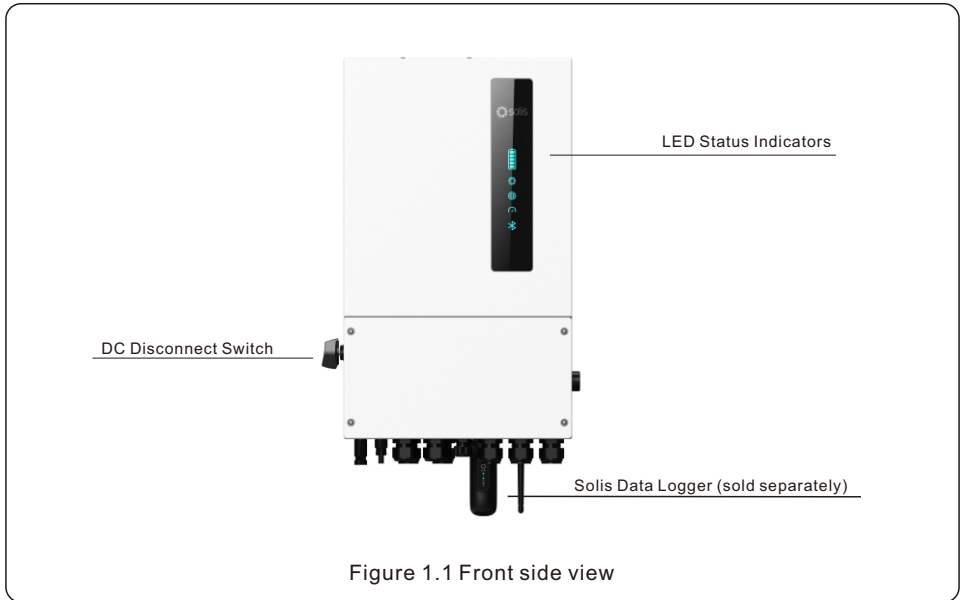

Figure 1.1 Front side view

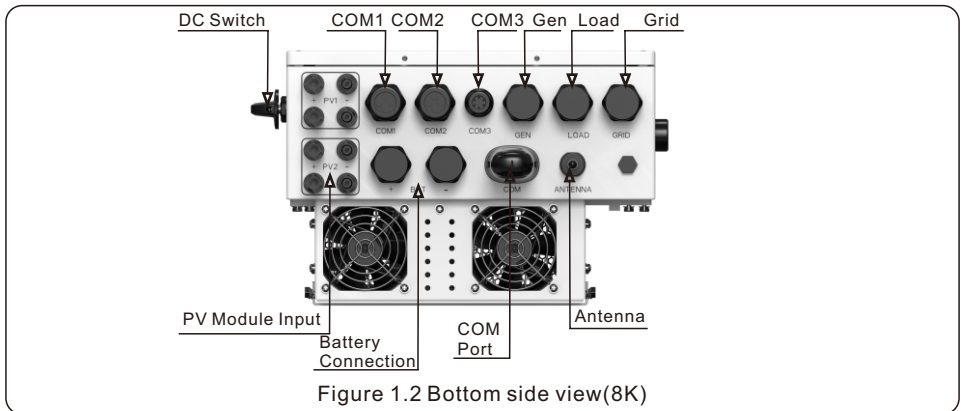
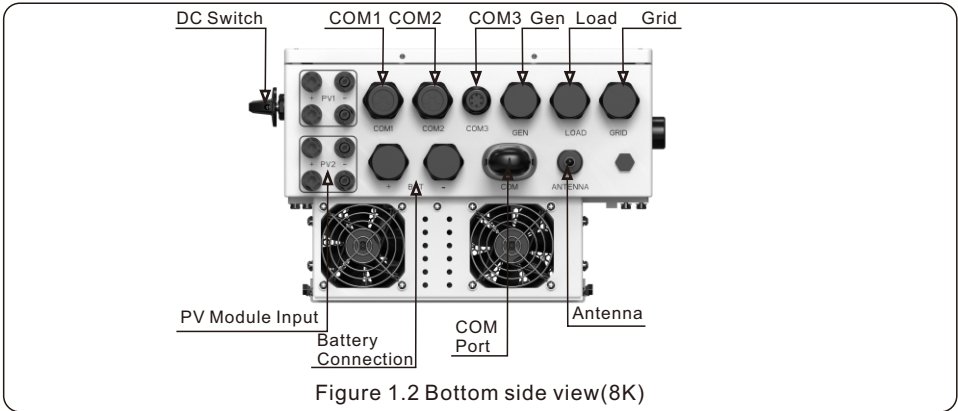

Figure 1.2 Bottom side view(8K)

1.2 Inverter Wire Box and Connection Points



Name	Description
1. DC Switch	This is the DC disconnect switch for the PV
2. COM1	RS485 and CAN communication cables and parallel cables should go through these
3. COM2	RS485 and CAN communication cables and parallel cables should go through these
4. COM3	Conduit for CT conductors should be connected here
5. Gen	Conduit for AC conductors to generator should be connected here
6. Load	Conduit for AC conductors to backup loads panel should be connected here
7. Grid	Conduit for AC conductors to the main service panel should be connected here
8. PV Module Input	Conduit for PV conductors should be connected here
9. Battery Connection	Conduit for Battery conductors should be connected here
10. COM Port	Solis data logger gets connected here-only USB version of the loggers will work
11. Antenna	Extends the range of the inverter Bluetooth signal(for system commissioning)

1.3 Product Features

Highly Flexible

- Integrated 2 MPPTs with 2(3-6K)/3(8K) strings, suitable for residential rooftop installations with multiple array orientations.
- Compatible with multiple brands of battery models giving customers multiple battery options.
- Exquisite LED Indicators with built in Bluetooth to provide local operation without Internet.

Outstanding Performance

- Up to 16A(3-6K)/32A (8K)of MPPT current input to support 182/210mm solar panels.
- Supports 1.6 DC:AC ratio to connect more PV capacity to the energy storage system.
- Up to 135A/6K, 190A/8K max.charge/discharge rating with industry highest level 8kW of backup loads support capability.
- UPS level switching time(<4ms)supporting critical loads all the time.
- High PV charge efficiency to prevent excess PV loss.
- 10 second 200% surge power backup overload capability. Support inductor loads.

Intelligent Function

- Supports up to 6 unit in parallel on Grid and Backup.Suitable for small to medium level commercial energy storage systems.
- Controllable and Upgraded via the SolisCloud APP to avoid site visits.
- Integrating AC coupling function with PV grid-connected inverters.
- Supports 6 customized charge and discharge time set with defined charging source.
- Supports self of use/feed in priority/peak-shaving/off-grid and other working modes to meet different application scenarios.
- Supports battery saving mode to reduce the battery consumption down to 0W during night time standby period.
- Generator connectivity with multiple input methods and automatic generator On/Off control.
- Support 2 backup control for load shielding during off grid mode.

Safe&Reliable

- Safety protection with integrated AFCI function, which actively detects arc faults in the PV Array.
- Multiple battery protection function.

1.4 Packaging

Please ensure that the following items are included in the packaging with your machine:

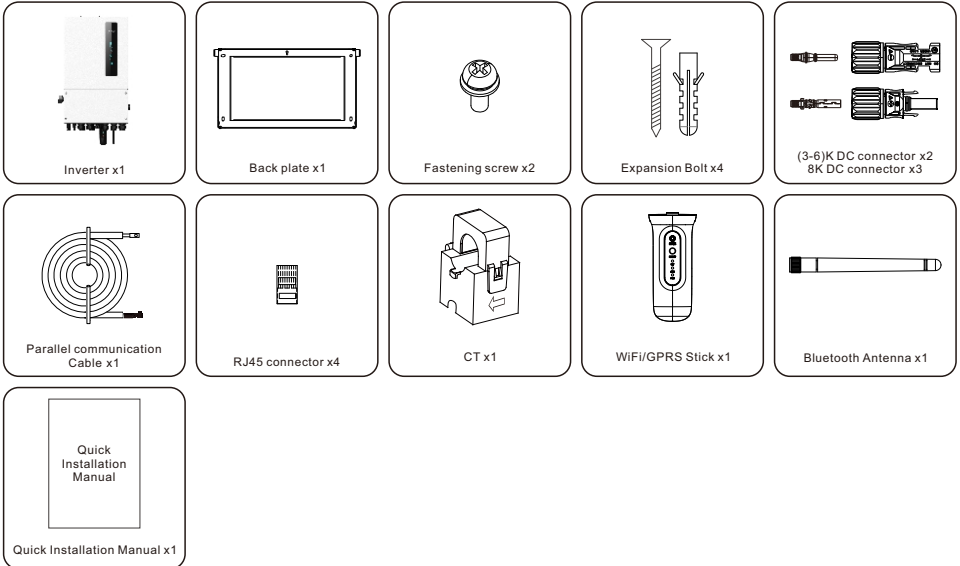

If anything is missing, please contact your local Solis distributor.

1.5 Tools Required for Installation



2.1 Safety

The following types of safety instructions and general information appear in this document as described below:



DANGER

“Danger” indicates a hazardous situation which if not avoided, will result in death or serious injury.



WARNING

“Warning” indicates a hazardous situation which if not avoided, could result in death or serious injury.



CAUTION

“Caution” indicates a hazardous situation which if not avoided, could result in minor or moderate injury.



NOTE

“Note” provides tips that are valuable for the optimal operation of your product.



WARNING: Risk of fire

Despite careful construction, electrical devices can cause fires.

- Do not install the inverter in an area containing flammable materials or gases.
- Do not install the inverter in a potentially explosive atmosphere.

2.2 General Safety Instructions



WARNING

Only devices in compliance with SELV (EN 69050) may be connected to the RS485 and USB interfaces.



WARNING

Do not connect PV array positive (+) or negative (-) to ground, doing so could cause serious damage to the inverter.



WARNING

Electrical installations must be done in accordance with local and national electrical safety standards.



WARNING

Do not touch any internal parts until 5 minutes after disconnection from the utility grid, PV array, and battery.



WARNING

To reduce the risk of fire, over-current protective devices (OCPD) are required for all circuits connected to the inverter.

The DC OCPD shall be installed per local requirements. All photovoltaic source and output circuit conductors shall have isolators that comply with the NEC Article 690, Part II.

All Solis single phase inverters feature an integrated DC disconnect switch.



CAUTION

Risk of electric shock, do not remove the cover. There are no serviceable parts inside, refer servicing to qualified and accredited service technicians.



CAUTION

The PV conductors are energized with high voltage DC when the PV modules are exposed to sunlight.



CAUTION

The surface temperature of the inverter can reach up to 75°C.

To avoid risk of burns, do not touch the surface of the inverter while it is operating. The inverter must be installed out of direct sunlight exposure.



NOTE

PV modules used with inverter must have an IEC 61730 Class A rating.



WARNING

Operations must be accomplished by a licensed electrician or a person authorized by Solis.



WARNING

Installer must wear personal protective equipment during the entire installation process in case of electrical hazards.



WARNING

The AC Backup Port of the inverter cannot be connected to the grid.



WARNING

Please refer to the product manual of the battery before installation and configuration to the inverter.



Systems using this product shall be designed and built in accordance with the NEC & local electrical codes & standards.

2.3 Notice for Use

The inverter has been constructed according to the applicable safety and technical guidelines, use the inverter in installations that meet the following specifications only:

1. Permanent installation is required.
2. The electrical installation must be compliant with all local and national regulations & standards.
3. The inverter must be installed according to the instructions stated in this manual.
4. The inverter must be installed according to the inverter technical specifications.

2.4 Notice for Disposal

This product shall not be disposed of with household waste.

It must be segregated and brought to an appropriate disposal facility to ensure proper recycling.

This is to be done in order to avoid negative impacts on the environment and human health.

Local waste management rules shall be observed and respected.



3.1 Select a Location to Install the Inverter

When selecting a location for the inverter, the following criteria should be considered:

- Exposure to direct sunlight may cause output power derating due to overheating. It is recommended to avoid installing the inverter in direct sunlight. The ideal location is one where the ambient temperature does not exceed 40°C.
- It is also recommended to install the inverter somewhere the rain and snow will not land directly on it. The ideal installation location is on a north-facing wall under an eave.

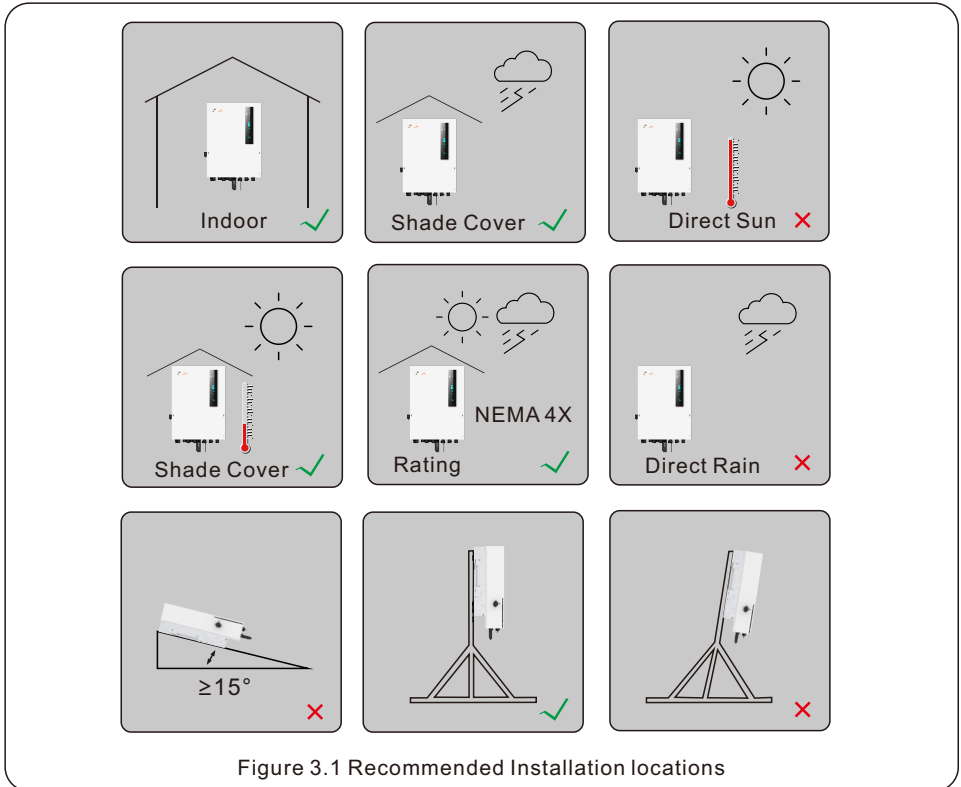

WARNING: Risk of fire



Despite careful construction, electrical devices can cause fires.

- Do not install the inverter in areas containing highly flammable materials or gases.
- Do not install the inverter in potentially explosive atmospheres.
- The mounting structure where the inverter is installed must be fireproof.

When selecting a location for the inverter, consider the following:

 **CAUTION: Hot Surface**

- The temperature of the inverter heat-sink can reach 75°C.

The ambient temperature and relative humidity of the installation environment should meet the following requirements:





 Max: +60°C	 Max: -40°C	 Max.RH : 100% (non-condensing)
--	--	---

Figure 3.2 Installation environment conditions

 **Load bearing surface:**
Made of non-inflammable materials

 Max. load bearing capacity \geq 4 times of inverter weight

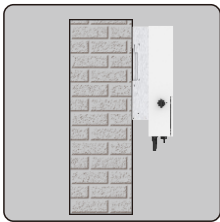

Figure 3.3 Load bearing structure

3.1.1 Clearances

- If multiple inverters are installed on site, a minimum clearance of 150mm should be kept between each inverter and all other mounted equipment. The bottom of the inverter should be at least 800mm above of the ground or floor.
- The LED status indicator lights located on the inverter's front panel should not be blocked
- Adequate ventilation must be present if the inverter is to be installed in a confined space.

3.1.2 Consult technical data

- Consult the technical specifications sections at the end of this manual for additional environmental condition requirements (temperature range, altitude, etc.)

3.1.3 Angle of installation

- This model of Solis inverter must be mounted vertically (90 degrees or backwards less than or equal to 15 degrees from 90 degrees straight up).

3.1.4 Avoiding direct sunlight

Installation of the inverter in a location exposed to direct sunlight should to be avoided.

Direct exposure to sunlight could cause:

- Power output limitation (with a resulting decreased energy production by the system).
- Premature wear of the electrical/electromechanical components.
- Premature wear of the mechanical components (gaskets) and user interface.

3.1.5 Air circulation

Do not install in small, closed rooms where air cannot freely circulate.

To prevent overheating, always ensure that the air flow around the inverter is not blocked.

3.1.6 Flammable substances

Do not install near flammable substances. Maintain a minimum distance of three meters (10 feet) from such substances.

3.1.7 Living area

Do not install in a living area where the prolonged presence of people or animals is expected.

Depending on where the inverter is installed (for example: the type of surface around the inverter, the general properties of the room, etc.) and the quality of the electricity supply, the sound level from the inverter can be quite high.

3.2 Product Handling

Please review the instruction below for handling the inverter:

1. The red circles below denote cutouts on the product package.

Push in the cutouts to form handles for moving the inverter (see Figure 3.4).

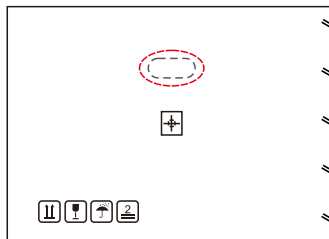

Figure 3.4 Handles used to move the inverter shown circled in red - one per side

2. Two people are required to remove the inverter from the shipping box. Use the handles integrated into the heat sink to remove the inverter from the carton.
3. When setting the inverter down, do it slowly and gently. This ensures that the internal components and the outer chassis do not take any damage.

3.3 Mounting the Inverter

- Mount the inverter on a wall or structure capable of bearing the weight of the machine.
- The inverter must be mounted vertically with a maximum incline of +/- 5 degree. Exceeding this may cause the output power to derate.
- To avoid overheating, always make sure the flow of air around the inverter is not blocked. A minimum clearance of 150mm should be kept between inverters or objects and 800mm clearance between the bottom of the machine and the ground.

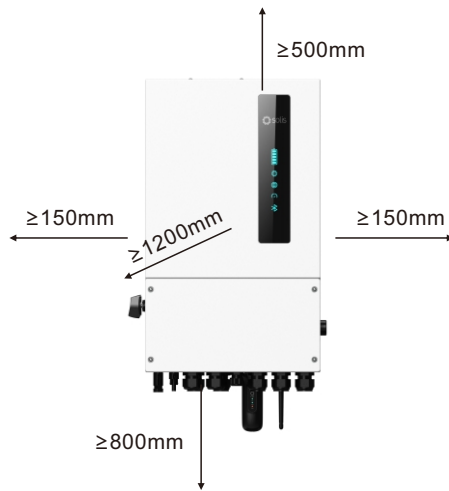

Figure 3.5 Inverter Mounting Clearances

- Visibility of the LED indicator lights should be considered.
- Adequate ventilation around the inverter must be provided.



NOTE

Nothing should be stored on top of or placed against the inverter.

Dimensions of mounting bracket:

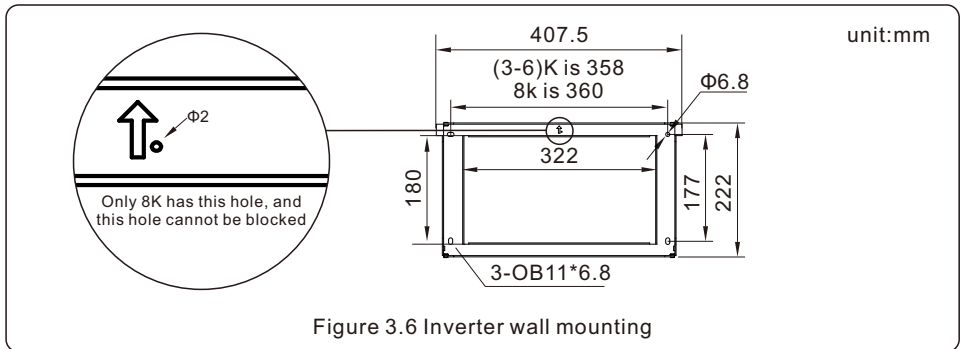

Once a suitable location has been found accordingly to 3.1 using figure 3.6 mount the wall bracket to the wall.

The inverter shall be mounted vertically.

The steps to mount the inverter are listed below:

1. Select the mounting height of the bracket and mark the mounting holes.
For brick walls, the position of the holes should be suitable for the expansion bolts.
2. Lift up the inverter (be careful to avoid body strain), and align the back bracket on the inverter with the convex section of the mounting bracket. Hang the inverter on the mounting bracket and make sure the inverter is secure (see Figure 3.7)

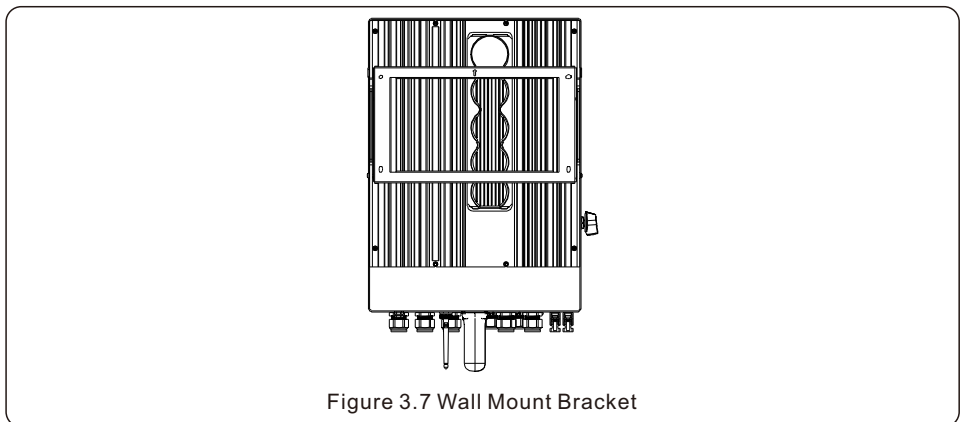

WARNING:

The inverter must be mounted vertically.

3.4 Inverter Wiring Overview

	Purpose	Connection Points
PV Cables	PV DC connection to the inverter	From the PV array to the DC+ and DC- terminals in the inverter
Battery Cables	Battery DC connection to the inverter	From the battery (+) and (-) terminals to the inverter BAT+ and BAT- terminals
AC Grid Cables	Inverter AC connection to the main service panel	From the OCPD in the main service panel to the AC-GRID L1 and L2 terminals
AC Backup Cables	Inverter AC connection to the backup subpanel	From the backup loads subpanel OCPD to the inverter AC-BACKUP L1 and L2 terminals
Ground Cables	Grounding conductors for the system	From the main service panel ground bar to the ground bar inside the inverter wire box
CT cable	Communication between inverter & CT	From CT to terminal HM. For more details, refer to figure Installing the energy meter
Battery CAN cable	Communication between the inverter & the battery	From battery to terminal BMS. For more details, refer to figure Installing the battery
Data Logger (Optional)	Monitoring of the system on SolisCloud	USB COM port at the bottom of the inverter (For more details, please refer to the Solis data logger product manual)



NOTE

Conductor dimensions and OCPD sizing to be determined in accordance with the national electrical code (NEC) and local standards.

3.5 Ground Cable Installation

An external ground connection is provided at the right side of inverter.

Prepare OT terminals: M4. Use proper tooling to crimp the lug to the terminal.

Connect the OT terminal with ground cable to the right side of inverter. The torque is 2N.m.

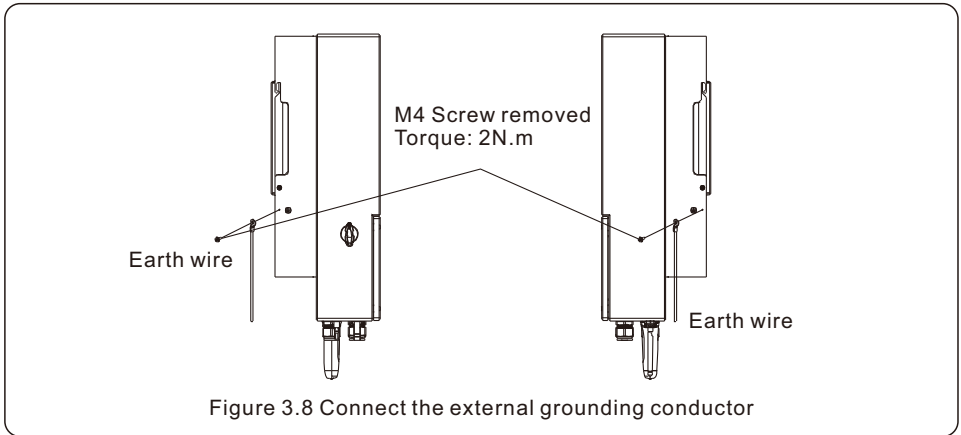

Figure 3.8 Connect the external grounding conductor

To connect the grounding terminal on the heat sink, please follow the steps below:

1. It is recommended to use copper wire for the chassis ground. Either solid conductor or stranded wire is acceptable. Refer to local code standard for wire sizing.
2. Attach OT terminal: M4.



IMPORTANT

For multiple inverters in parallel, all inverters should be connected to the same ground point to eliminate the possibility of a voltage potential existing between inverter grounds.

3. Strip the ground cable insulation to a suitable length. (see Figure 3.9)
4. Crimp a ring connector onto the cable and then connect it to the chassis ground terminal.

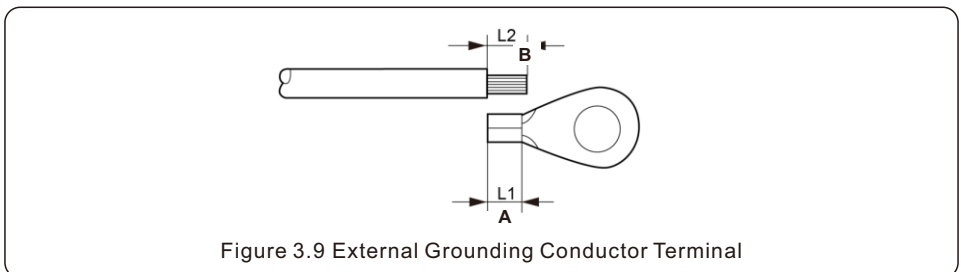

Figure 3.9 External Grounding Conductor Terminal

5. The external grounding conductor is recommended to be connected to 4mm² and above.

3.6 PV Cable Installation



Before connecting inverter, please make sure the PV array open circuit voltage is within the limit of the inverter.



Before connection, please make sure the polarity of the output voltage of PV array matches the "DC+" and "DC-" symbols.



Please use approved DC cable for PV system.

1. Select a suitable DC cable and strip the wires out by $7 \pm 0.5 \text{ mm}$. Please refer to the table below for specific specifications.

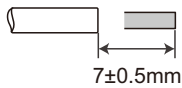

Cable type	Cross section (mm ²)	
	Range	Recommended value
Industry generic PV cable	4.0~6.0 (12~10AWG)	4.0 (12AWG)

Figure 3.10

2. Take the DC terminal out of the accessory bag, turn the screw cap to disassemble it, and take out the waterproof rubber ring.

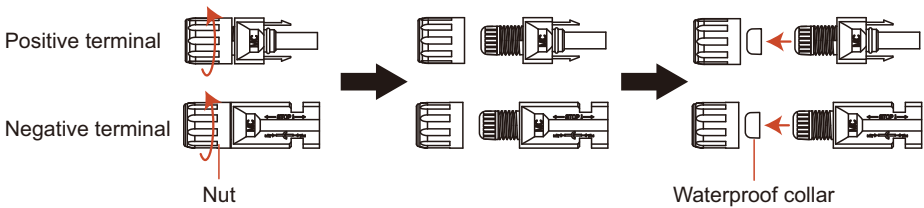
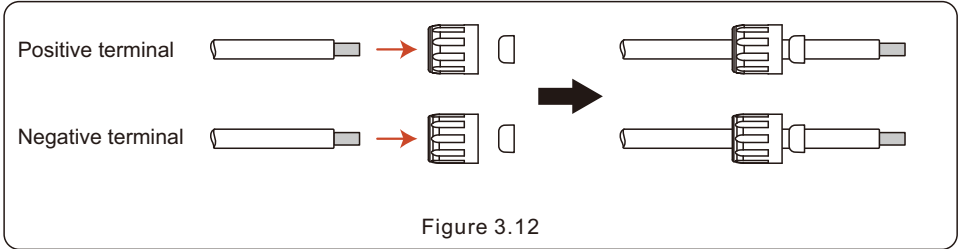
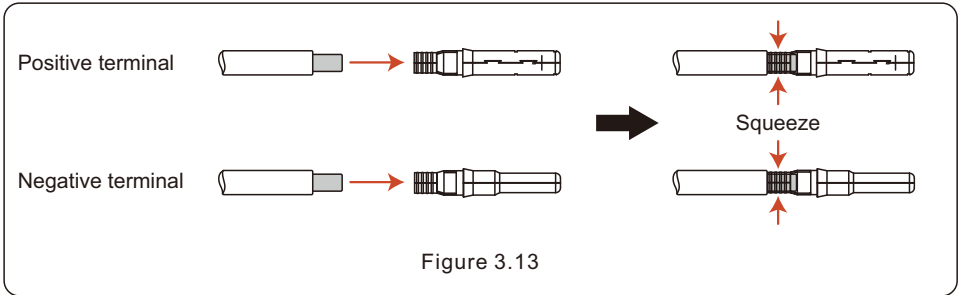

Figure 3.11

3. Pass the stripped DC cable through the nut and waterproof rubber ring.



4. Connect the wire part of the DC cable to the metal DC terminal and crimp it with a special DC terminal crimping tool.



5. Insert the crimped DC cable into the DC terminal firmly, then insert the waterproof rubber ring into the DC terminal and tighten the nut.

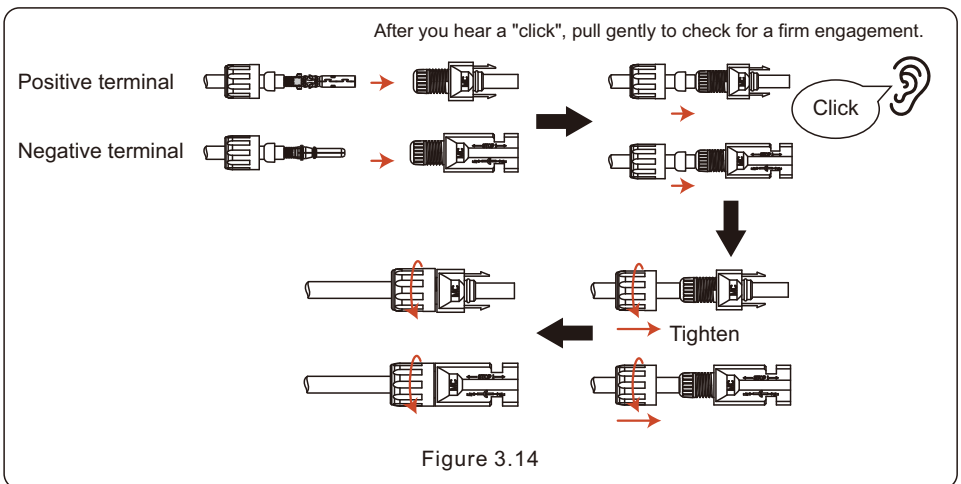

6. Measure PV voltage of DC input with multimeter, verify DC input cable polarity.

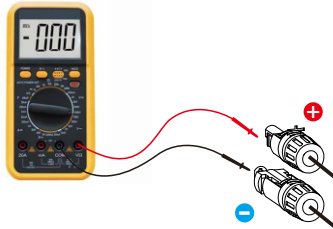

Figure 3.15

7. Connect the wired DC terminal to the inverter as shown in the figure, and a slight "click" is heard to prove the connection is correct.

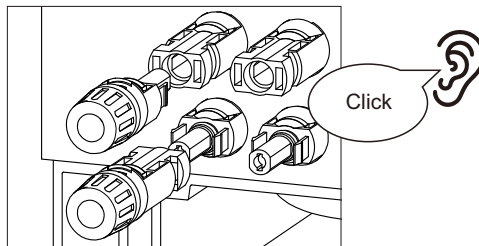

Figure 3.16



CAUTION:

If DC inputs are accidentally reversely connected or inverter is faulty or not working properly, it is NOT allowed to turn off the DC switch. Otherwise it may cause DC arc and damage the inverter or even lead to a fire disaster. The correct actions are:

*Use a clip-on ammeter to measure the DC string current.

*If it is above 0.5A, please wait for the solar irradiance reduces until the current decreases to below 0.5A.

*Only after the current is below 0.5A, you are allowed to turn off the DC switches and disconnect the PV strings.

* In order to completely eliminate the possibility of failure, please disconnect the PV strings after turning off the DC switch to avoid secondary failures due to continuous PV energy on the next day.

Please note that any damages due to wrong operations are not covered in the device warranty.

3.7 Battery Cable Installation



DANGER

Before installing the battery cables, be sure that the battery is turned off. Use a multimeter to verify that the battery voltage is 0Vdc before proceeding. Consult the battery product manual for instructions on how to turn it off.

1. The battery (+) and (-) cables shall only be connected to the inverter BAT terminals.
2. Run the cables into the wire box. Strip 13mm off the ends of each cable.
3. Crimp the R-type connectors onto the cables. Do not over crimp the connectors.
4. Remove the terminal bolts and then insert them through the connector holes.
5. Put each bolt back into the proper place, be sure to not reverse the polarity.
6. Tighten the bolts with a torque wrench screwdriver following the torque specs.

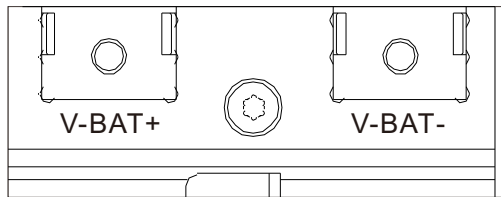
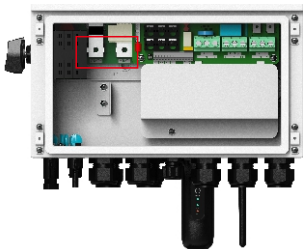

(3-6)K OT Terminal: R38-8, Recommended cable diameter: 2AWG

8K OT Terminal: R60-8, Recommended cable diameter: 1AWG

Figure 3.17 Battery cable connection



NOTE

The battery fuse in the inverter wire box is replaceable. The replacement can only be done by a technician authorized by Solis. Fuse specification: 70V 350A for 8K, 70V 200A for (3-6)K.



NOTE

Before connecting the battery, please carefully read the product manual of the battery and perform the installation exactly as the battery manufacturer specifies in the manual.

DC Breaker recommended size is 300A

3.8 AC Wiring



DANGER

Before installing the AC cables, be sure that the OCPDs (breakers) are turned off.

Use a multimeter to verify that the AC voltages are 0Vac before proceeding.

There are three sets of AC output terminals and the installation steps for both are the same.

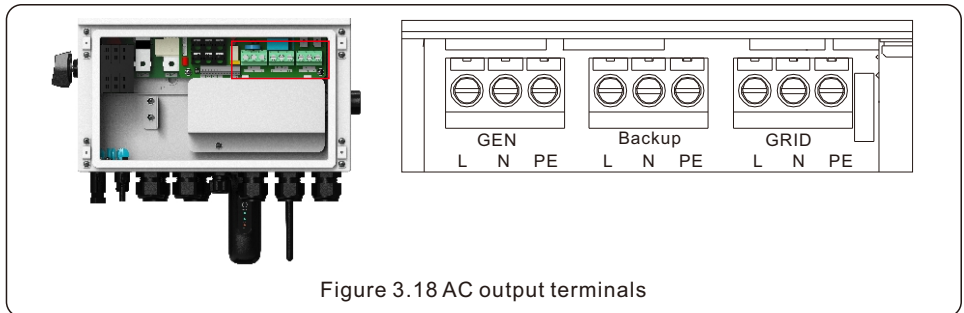

Figure 3.18 AC output terminals

Model	AC Grid	AC Backup/AC Gen
Terminal	C10-12	C6-12
Torque	4-5N.m	4-5N.m
Recommend cross section	8-6AWG	10-6AWG

1. Bring the AC cables for the backup loads panel (backup) and the main service panel (grid) into the inverter wire box. The backup loads panel should not be electrically connected to the main service panel.
2. Strip 13mm from the ends of each cable. Crimp the R-type connectors onto the ends.
3. Remove the terminal bolts, insert them into the connectors, then use a torque wrench to tighten the bolts down.
4. Please refer to the terminal labels to connect the AC wires to the correct terminals.
5. AC Breaker recommended size: 100A, leakage current protector recommended Type C.

3.9 Meter/CT Connection



CAUTION:

Make sure the AC cable is totally isolated from AC power before connecting the smart meter or CT.

3.9.1 CT Installation

The CT provided in the product box is compulsory for hybrid system installation. It can be used to detect the grid current direction and provide the system operating condition to hybrid inverter.

CT Model: ESCT-TA16-100A/50mA

CT Cable: Size – 2.3mm², Length - 1m

Please install the CT on the hot line at the system grid connection point and the arrow on the CT needs to point to the grid direction.

Lead the CT wires through the COM3 port at the bottom of the inverter and connect the CT wires to the 12pin communication terminal block.

CT Wire	12 PIN Communication Terminal Block
White	Pin 1 (From Left to Right)
Black	Pin 2 (From Left to Right)

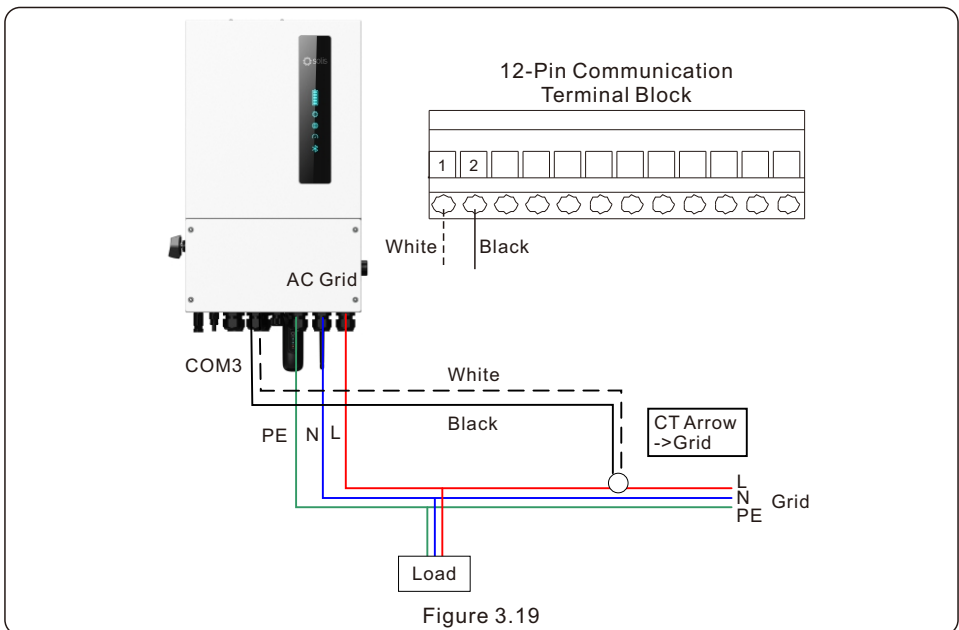

Figure 3.19

3.9.2 Meter Installation (Optional)

If a smart meter is preferred to be installed other than the provided CT, please contact Solis sales rep to order the smart meter and corresponding meter CT.

Meter Model: SDM120CTM (With CT)

Please install the Meter's CT on the hot line at the system grid connection point and the arrow on the Meter's CT needs to point to the grid direction.

Lead the Meter RS485 wires through the COM1 or COM2 port at the bottom of the inverter and connect to the Meter RJ45 terminal.

RS485 Pins on the meter	Meter RJ45 Terminal (EIA/TIA 568B)
Pin 9 – RS485B	Pin 2 Orange – RS485B
Pin 10 – RS485A	Pin 1 Orange/White – RS485A

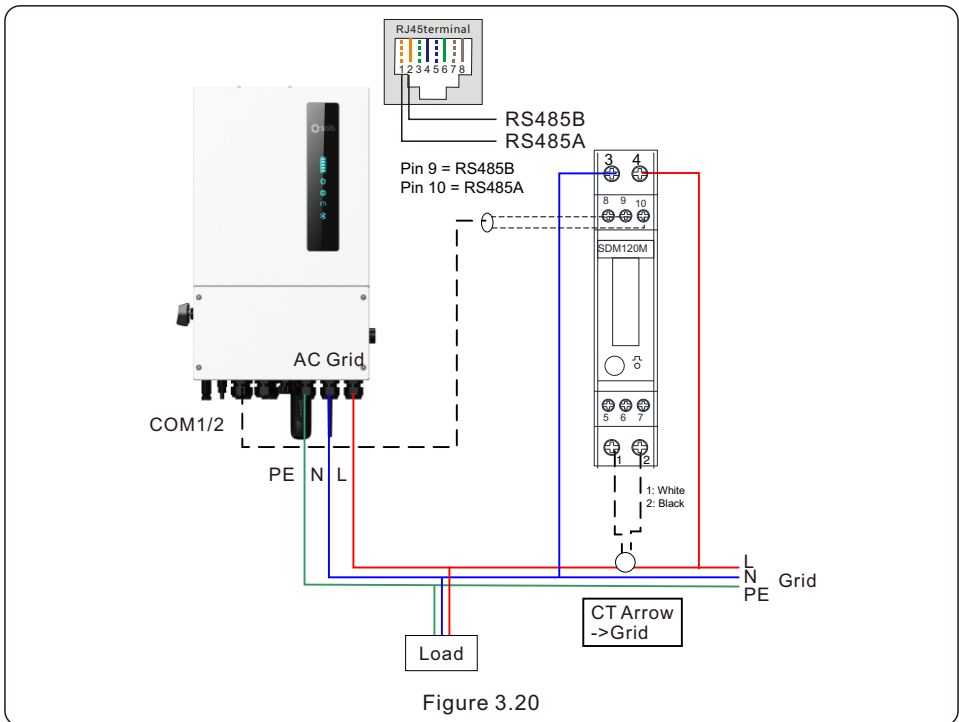
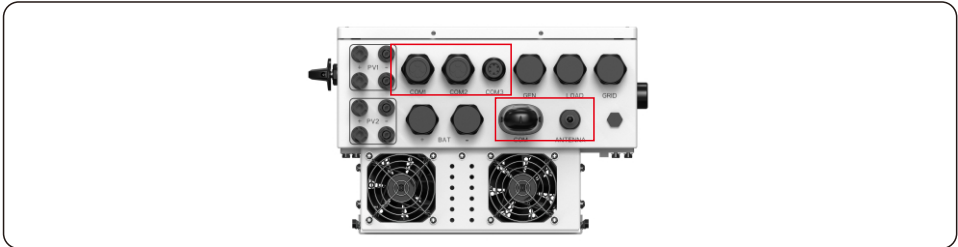

Figure 3.20

3.10 Inverter Communication

3.10.1 Communication Ports



Port	Port Type	Description
COM	USB	Used for Solis data logger connection
ANTENNA	Antenna	Used for Antenna connection for built in Bluetooth signal
COM1	4 hole watertight cable gland	Used for RJ45 connection inside wiring box
COM2	4 hole watertight cable gland	Used for RJ45 connection inside wiring box
COM3	6 hole watertight cable gland	Used for 12 PIN terminal block connection inside wiring box

Wiring steps for COM1-COM3:

Step 1. Loose the cable gland and remove the watertight caps inside the cable gland based on the number of the cables and keep the unused holes with watertight cap.

Step 2. Lead the cable into the holes in the cable gland.

(COM1-COM2 Hole Diameter: 6mm, COM3 Hole Diameter: 2mm)

Step 3. Connect the cable to the corresponding terminals inside the wiring box.

Step 4. Reassemble the cable gland and ensure there is no bending or stretching of the cables inside the wiring box.



NOTE:

The 4-hole fastening rings inside the cable gland for COM1 and COM2 are with openings on the side.

Please separate the gap with hand and squeeze the cables into the holes from the side openings.

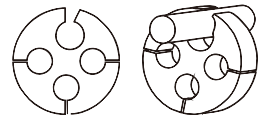

3.10.2 Communication Terminals

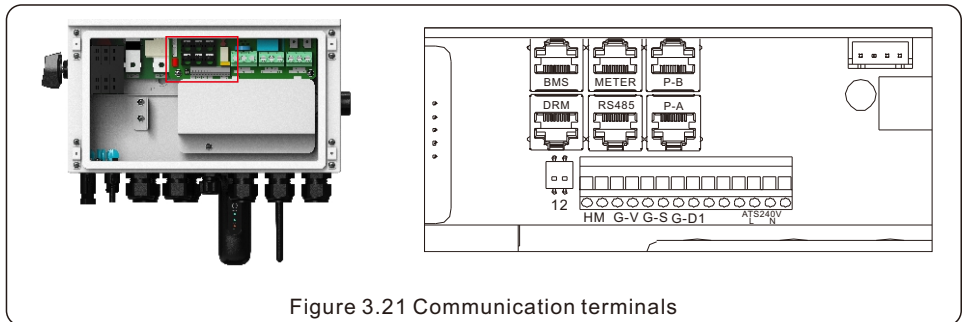

Figure 3.21 Communication terminals

Terminal	Type	Description
BMS	RJ45	Used for CAN communication between inverter and Lithium battery BMS. Used for Battery temperature sensor between inverter and lead-acid battery.
Meter	RJ45	(Optional)Used for RS485 communication between inverter and the smart meter.
DRM	RJ45	(Optional) To realize Demand Response or Logic Interface function, this function may be required in UK and Australia.
RS485	RJ45	(Optional) Used for Modbus RTU communication with 3rd party external device or controller.
P-A	RJ45	(Optional) Parallel operation communication port.
P-B	RJ45	(Optional) Parallel operation communication port.
DIP Switch (2-1)	-	When a single inverter is running, DIP switch 1 and 2 shall be both at the bottom position. When multiple inverters are paralleled, DIP switch: Option 1: Both the first and last inverter (INV1 & INV3) have 1 of the DIP switch enabled (Either Pin1 or Pin2). Option 2: One of the first and the last inverter (INV1 or INV3) has 2 DIP switches enabled (Both Pin1 & Pin2)
HM	Terminal Block	Pin 1 & Pin 2 (From Left to Right) Used for CT wire connection.
G-V	Terminal Block	Pin 3 & Pin 4 (From Left to Right) Used for Generator start-stop signal.
G-S	Terminal Block	Pin 5 & Pin 6 (From Left to Right)Reserved.
ATS240V	Terminal Block	Pin 10(L) & Pin 12(N) (From Left to Right) 240V ATS Signal.

3.10.3 BMS Terminal Connection

3.10.3.1 With Lithium Battery

CAN communication is supported between inverter and compatible battery models. Please lead the CAN cable through the COM1 or COM2 port of the inverter and connect to the BMS terminal with RJ45 connector.

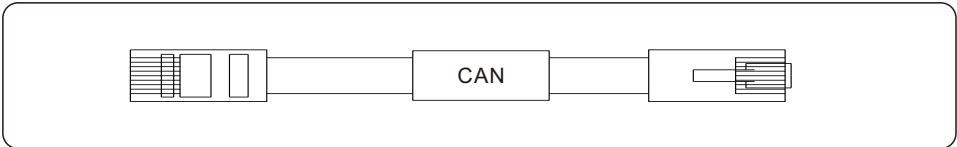

NOTE:



Before connecting CAN cable with the battery, please check whether the communication pin sequence of the inverter and the battery match; If it does not match, you need to cut off the RJ45 connector at one end of the CAN cable and adjust the pin sequence according to the pin definitions of both inverter and battery.

Pin definition of the inverter BMS Port is following EIA/TIA 568B.

CAN-H on Pin 4: Blue

CAN-L on Pin 5: Blue/White

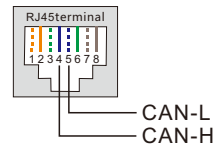

3.10.3.2 With Lead-acid Battery

When Lead-acid battery is used, battery temperature sensor needs to be connected to the BMS terminal of the inverter.

Step 1. Take out the battery temperature sensor cable and lead through the COM1 or COM2 port of the inverter and connect the RJ45 connector to the BMS terminal.

Step 2. Fasten the temperature sensor ring onto the battery module. If no suitable fastening terminal can be found on the battery module, the sensor ring can be attached to the positive or negative pole of the battery module.

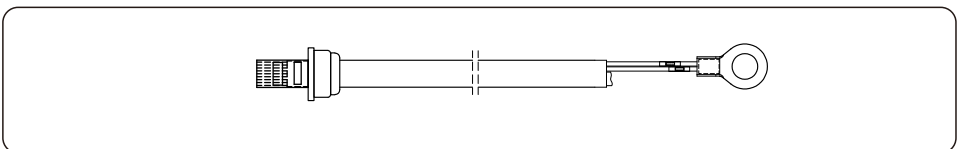

3.10.4 Meter Terminal Connection (Optional)

If a smart meter is preferred to be installed other than the provided CT, please contact Solis sales rep to order the smart meter and corresponding meter CT.

Please lead the Meter RS485 cable through the COM1 or COM2 port of the inverter and connect to the Meter terminal with RJ45 connector.

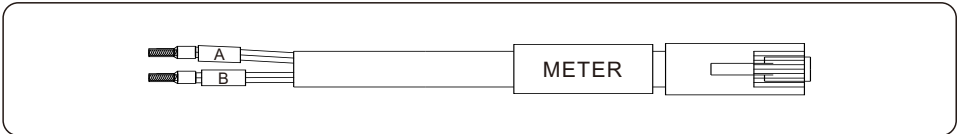

NOTE:

Pin definition of the Meter Terminal is following EIA/TIA 568B.

RS485A on Pin 1: Orange/white

RS485B on Pin 2: Orange

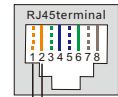

RS485B
RS485A



NOTE:

Compatible Smart Meter Pin Definition.

SDM120CTM (With CT) – Pin 9 is RS485B & Pin 10 is RS485A

3.10.5 DRM Port Connection (Optional)

3.10.5.1 For Remote Shutdown Function

Solis inverters support remote shutdown function to remotely control the inverter to power on and off through logic signals.

The DRM port is provided with an RJ45 terminal and its Pin5 and Pin6 can be used for remote shutdown function.

Signal	Function
Short Pin5 and Pin6	Inverter Generates
Open Pin5 and Pin6	Inverter Shutdown in 5s

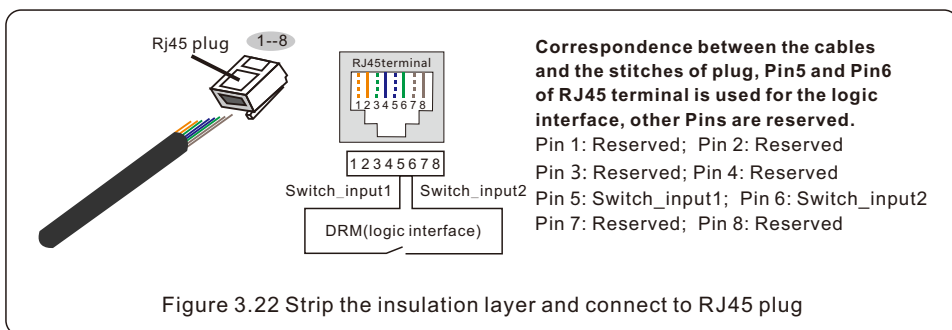

3.10.5.2 For DRED Control Function (For AU and NZ Only)

DRED means demand response enable device. The AS/NZS 4777.2:2020 required inverter need to support demand response mode(DRM).

This function is for inverter that comply with AS/NZS 4777.2:2020 standard.

A RJ45 terminal is used for DRM connection.

Pin	Assignment for inverters capable of both charging and discharging	Pin	Assignment for inverters capable of both charging and discharging
1	DRM 1/5	5	RefGen
2	DRM 2/6	6	Com/DRM0
3	DRM 3/7	7	V+
4	DRM 4/8	8	V-



NOTE:

Solis hybrid inverter is designed to provide 12V power for DRED.

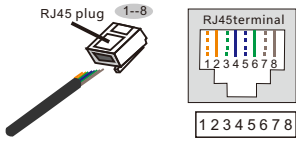

Correspondence between the cables and the stitches of plug
 Pin 1: white and orange ; Pin 2: orange
 Pin 3: white and green; Pin 4: blue
 Pin 5: white and blue; Pin 6: green
 Pin 7: white and brown; Pin 8: brown

Figure 3.23 Strip the insulation layer and connect to RJ45 plug

3.10.6 RS485 Port Connection (Optional)

If a 3rd party external device or controller needs to communicate with the inverter, the RS485 port can be used. Modbus RTU protocol is supported by Solis inverters.

To acquire latest protocol document, please contact Solis local service team or Solis sales.



NOTE:
 Pin definition of the RS485 Port is following EIA/TIA 568B.
 RS485A on Pin 5: Blue/White
 RS485B on Pin 4: Blue

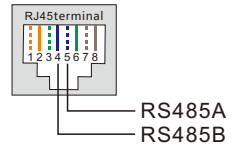

3.10.7 Parallel Terminal Connection (Optional)

Up to 6 units of the inverter can be connected in parallel.

Please connect the paralleled inverters in daisy chain by using P-A and P-B terminals.

Standard CAT5 with shielding layers internet cable can be used.

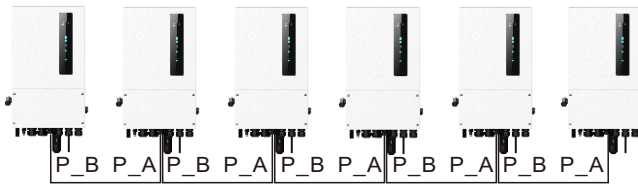
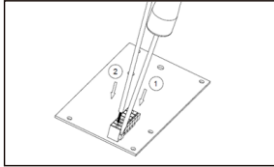

Figure 3.24 Parallel Terminal Connection

3.10.8 12-pin Communication Terminal Block

Terminal Block Connection Steps:

- Step 1. Lead the wires through the hole in COM3 port (Hole Diameter: 2 mm)
- Step 2. Strip the wires for 9mm length
- Step 3. Use slot type screwdriver to press the block on the top
- Step 4. Insert the exposed copper part of the cable into the terminal.
- Step 5. Remove the screwdriver and the terminal will clamp down on the exposed copper part.
- Step 6. Give the cable a gentle tug to ensure that it is firmly secured.



3.10.8.1 HM Terminal Connection (CT Terminal Connection)

CT connection is necessary to realize the correct control logic of the hybrid inverter, unless the smart meter is used as stated in section 3.10.4 and section 3.9.

The CT provided in the inverter package has BLACK(S2) and WHITE(S1) wires. The BLACK wire needs to connect to the Pin 2 of the terminal block and the WHITE wire needs to connect to the Pin 1 of the terminal block as in the following diagram.

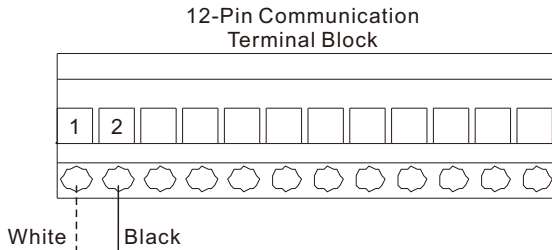

Figure 3.25

3.10.8.2 G-V Terminal Connection

The G-V terminal is a voltage-free dry contact signal for connecting with generator's NO relay to start up the generator when necessary.

When generator operation is not needed, Pin3 and Pin4 is in open circuit.

When generator operation is needed, Pin3 and Pin4 is in short circuit.

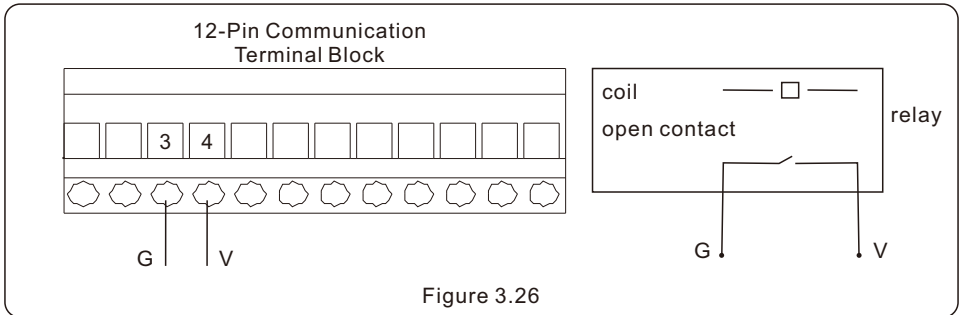

3.10.8.3 ATS240V Terminal Connection

The ATS240V terminal will output 230V AC voltage when inverter is connected to the grid and when inverter is connected to the generator, it will output 0V.

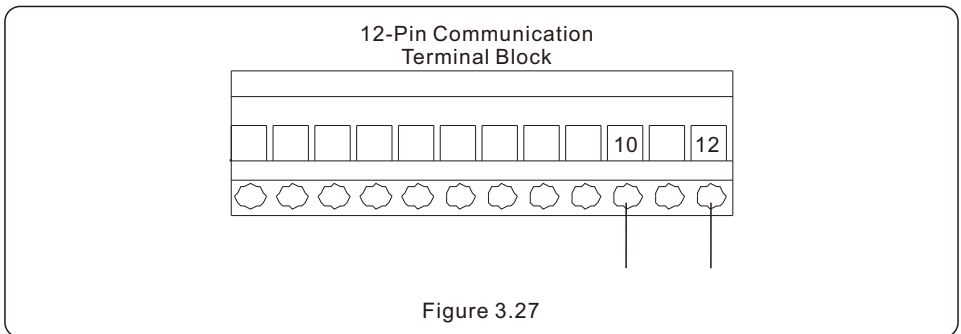

3.11 Diesel Generator Wiring

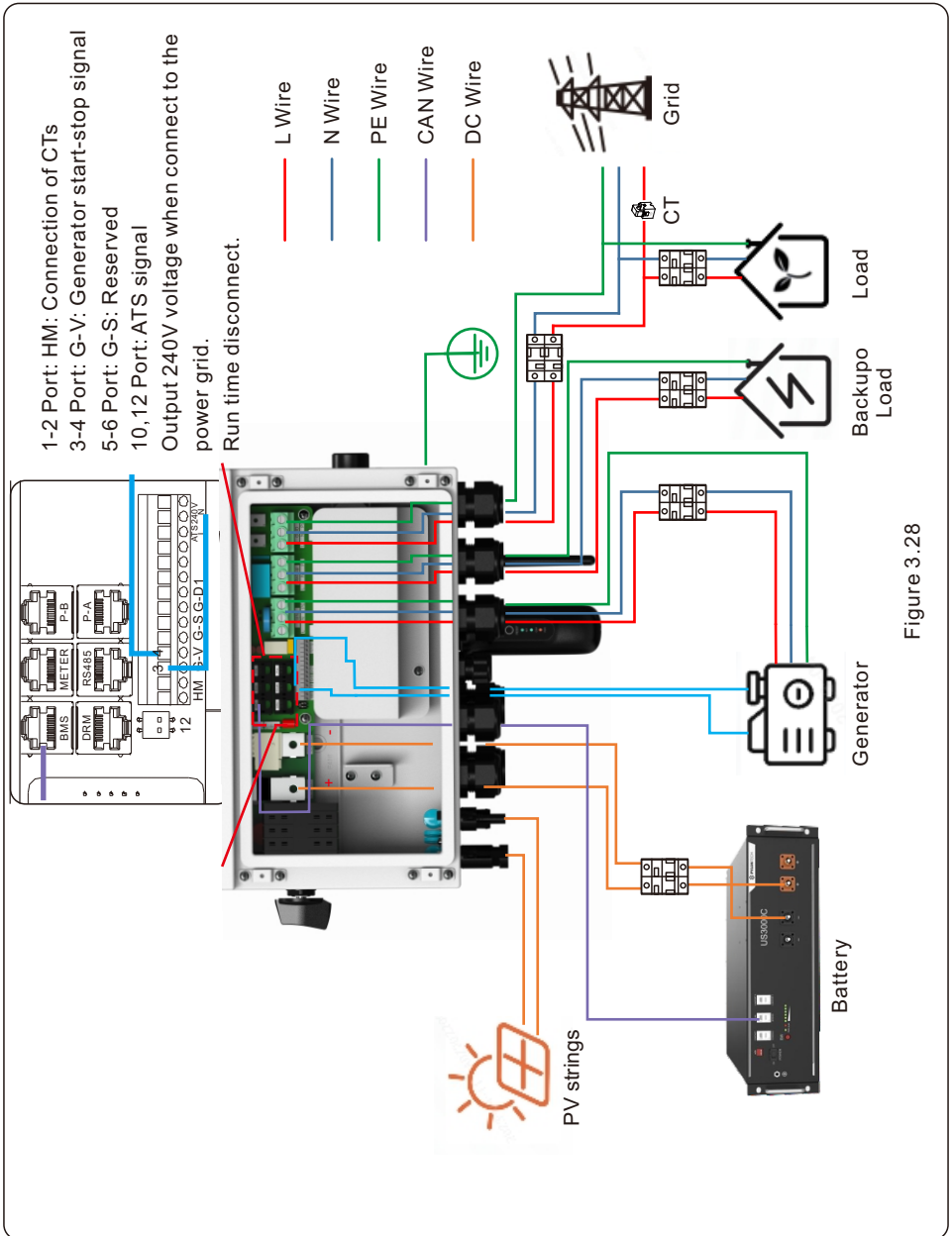

Figure 3.28

3.12 Parallel System Wiring

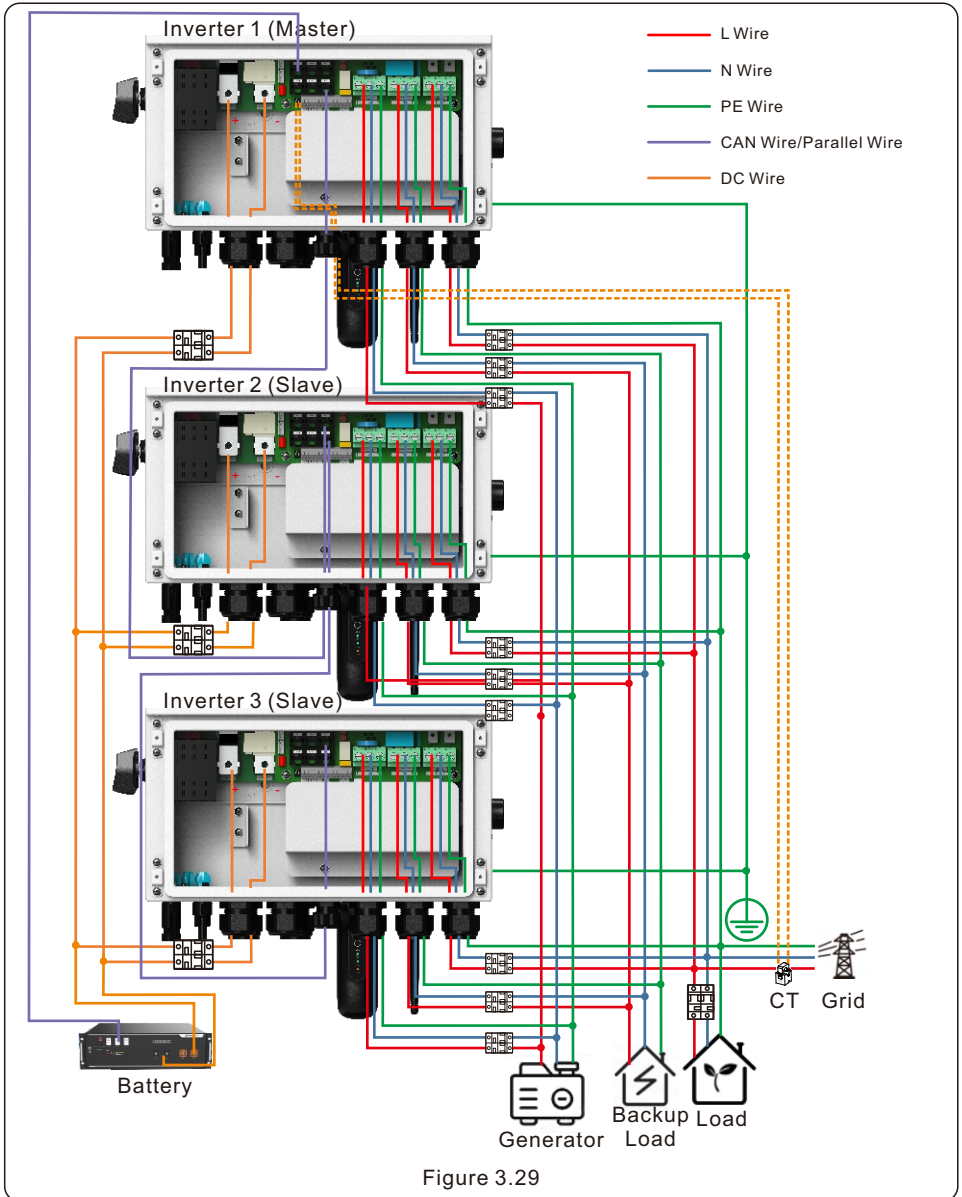
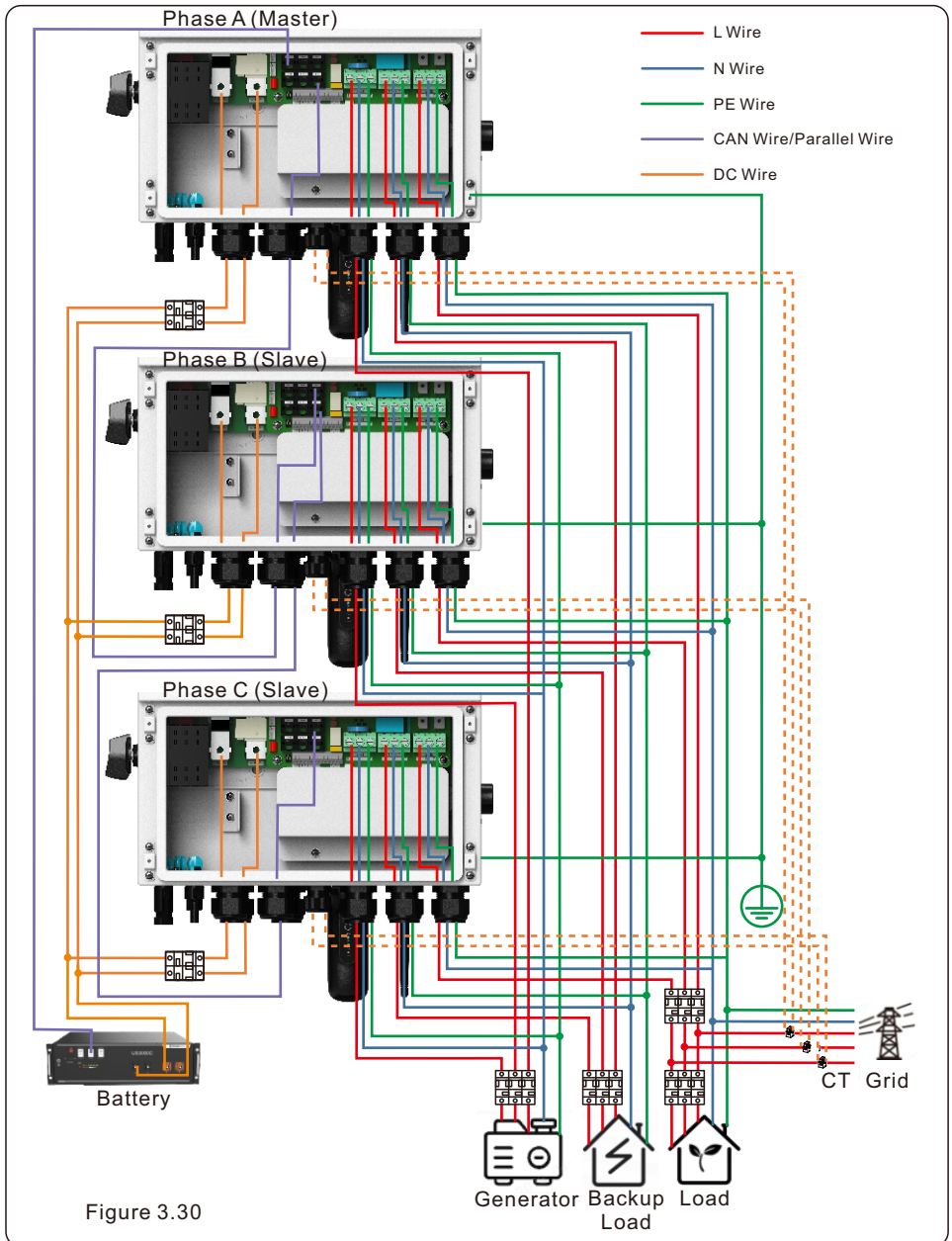

Figure 3.29

When multiple inverters are connecting in parallel, ONLY same model (same power rating) can be used.



When multiple inverters are connecting in parallel, ONLY same model (same power rating) can be used.

3.13 Inverter Remote Monitoring Connection

The inverter can be remotely monitored via WiFi, LAN or 4G.

The USB type COM port at the bottom of the inverter can connect to different kinds of Solis data loggers to realize the remote monitoring on Soliscloud platform.

To install Solis data loggers, please refer to corresponding user manuals of Solis data loggers.

The Solis data loggers are optional and can be purchased separately.

Dust cover is provided the inverter package in case the port is not used.



WARNING:

The USB type COM port is only allowed to connect Solis data loggers. It is forbidden to be used for other purposes.

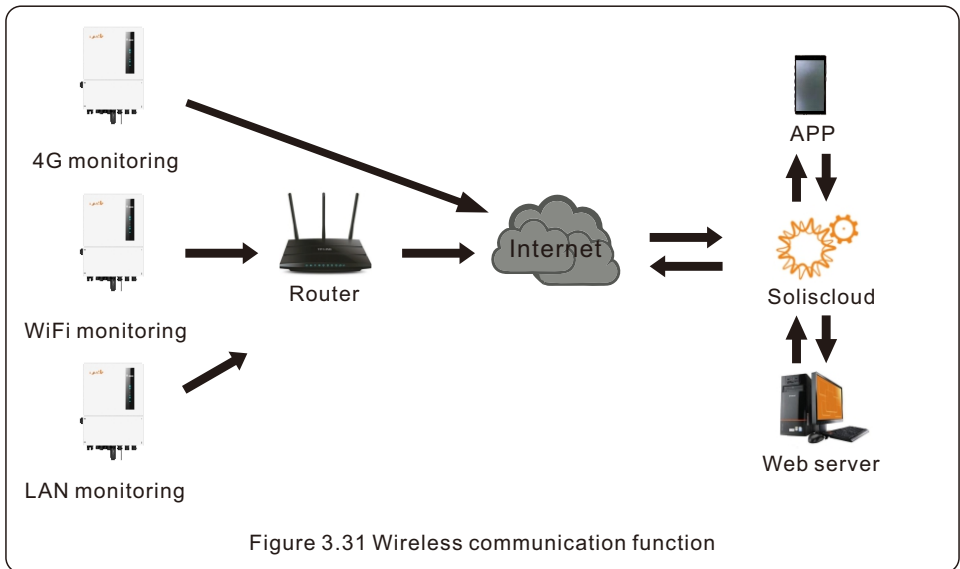
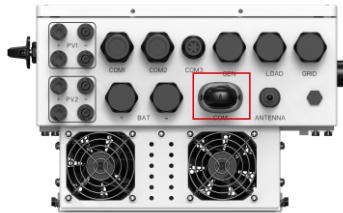







Figure 3.31 Wireless communication function

4.1 Intelligent LED Indicators

There are five indicators on the The Solis S6-EH1P(3-8)K-L-PLUS Series Inverter(Battery,Power, WiFi.Ethernet and Bluetooth)which indicate the working status of the inverter.

The Bluetooth Antenna or WiFi data logger shall be installed at the Antenna/COM port of the hybrid inverter before local debugging.

Light	Status	Description
 Battery	Blue Flashing every 3s	Battery discharging.
	Blue Flashing every 1.5s	Battery charging.
	Blue Solid ON	Idle.
	OFF	No Battery or not working.
 Power	Blue Solid ON	Normally Operating.
	Yellow Solid ON	Warning.
	Red Solid ON or flashing every 3s	Alarm.
	OFF	No Battery or not working.
 WiFi	Blue Solid ON	COM Port is using.
	OFF	COM Port is not used.
 RS485	Blue Solid ON	RS485 Port is using.
	OFF	RS485 Port is not used.
 Bluetooth	Blue Solid ON	Bluetooth Port is using.
	OFF	Bluetooth Port is not used.

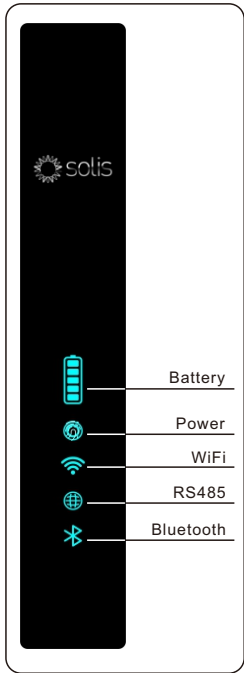

Turning On the LED Indicator Lights

After a few minutes, the LED indicator lights will turn off to conserve power. To turn the lights back on, short-press the Inverter LED light.



Alarm State

When the inverter has an alarm, the Inverter LED light turns red and starts flashing. It is recommended to connect to the inverter with the Bluetooth tool. Then you can determine what the alarm code is.



NOTE:

Battery/WiFi/Ethernet/Bluetooth indicators will automatically turn off after 1 minute. The Power indicator will remain on with lower brightness. Short press the Power indicator can wake up all indicators.



4.2 Password Reset

When the password of the owner or the installer needs to be reset, please long press the Inverter indicator for 5s.

If the reset command is successfully triggered, the status indicator will be blue and blink for 3s at the frequency of 0.5s, then restore the original state of the indicator.

If the command fails to be triggered, the status indicator will be yellow and blink for 3s at the frequency of 0.5s, then restore the original state of the indicator.

If the command is successfully triggered, the Bluetooth password can be reset in the APP.

4.3 Inverter built-in Bluetooth description

Bluetooth: BDR、EDR、BLE

frequency band(s) in which the radio equipment operates: 2.402-2.480GHZ

Maximum transmitting power: 8dBm

Hereby, Ginlong Technologies Co., Ltd. declares that the radio equipment type hybrid inverter is in compliance with Directive 2014/53/EU

5.1 Pre-Commissioning

- Make sure that no high voltage conductors are energized.
- Check all conduit and cable connection points ensure they are tight.
- Verify that all system components have adequate space for ventilation.
- Follow each cable to ensure that they are all terminated in the proper places.
- Ensure that all warning signs and labels are affixed on the system equipment.
- Verify that the inverter is secured to the wall and is not loose or wobbly.
- Prepare a multimeter that can do both AC and DC amps.
- Have an Android or Apple mobile phone with Bluetooth capability.
- Install the Soliscloud APP on the mobile phone and register a new account.
- There are three ways to download and install the latest APP.

- 1.You can visit www.soliscloud.com.
- 2.You can search"Soliscloud" in Google Play or APP Store.
- 3.You can scan this QR code to download Soliscloud.



5.2 Power ON

Step 1: With the DC switch off, energize the PV strings and then measure DC voltage of the PV strings to verify that the voltage and polarity are correct. Turn on the battery and check the battery voltage and polarity as well.

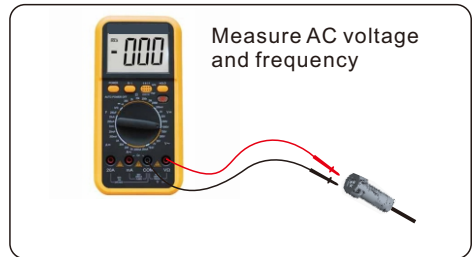
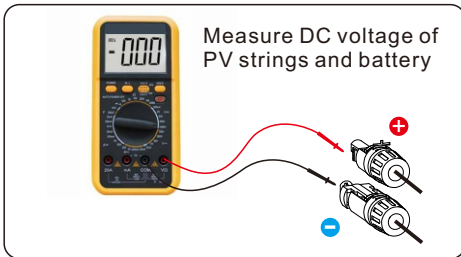

Step 2: Turn on the OCPD for the system and then measure the AC voltages line to line and line to neutral. The backup side of the system will be off until commissioning is complete. Turn the OCPD back off for now.

Step 3: Turn the DC switch on and then the OCPD(AC breaker) for the system.

This inverter can be powered on by PV only, battery only and Grid only.

When the inverter is powered on,the five indicators will be lighted at once.

5.3 Power OFF

Step 1: Turn off the AC breaker or AC disconnect switch to disable AC power to the inverter.

Step 2: Turn off the DC switch of the inverter.

Step 3: Turn off the battery breaker.

Step 4: Use a multimeter to verify that the battery and AC voltages are 0V.

5.4 Log in the APP via Bluetooth

Step 1: Connect with Bluetooth.

Turn on Bluetooth switch on your mobile phone and then open the Soliscloud APP. Click "More Tools"->"Local Operation"->"Connect with Bluetooth"

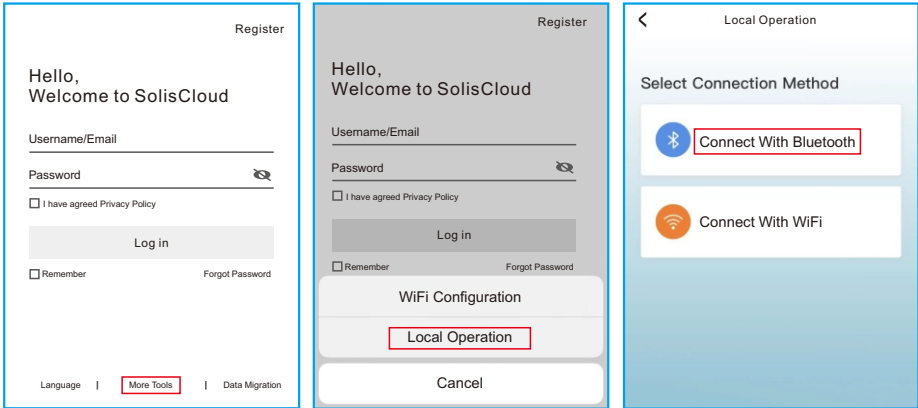

Step 2: Select the Bluetooth signal from the inverter. (Bluetooth Name: Inverter SN)



Step 3: Login account.

If you are the installer, please select the account type as Installer. If you are the plant owner, please select the account type as owner. Then set your own initial password for control verification. (The first log-in must be finished by installer in order to do the initial set up)

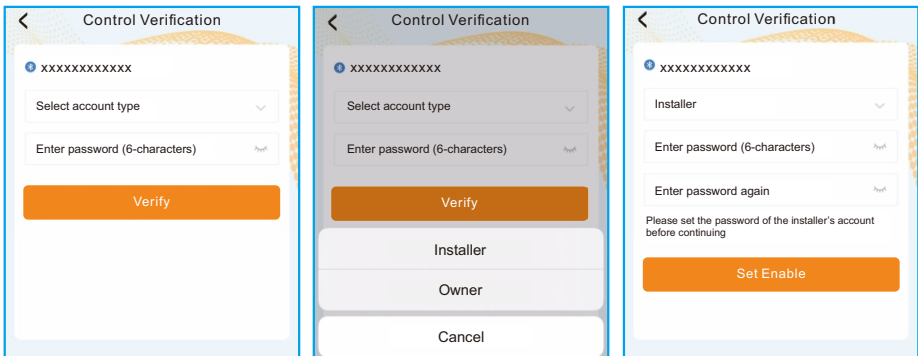

5.5 Initial set up

If this is the first time the inverter has been commissioned, you will need to first go through the Quick Settings. Once this has been done, these settings can be changed later.

Inverter Time -> Battery Model -> Meter Setting -> Grid Code -> Work mode

A. Inverter Time: Set the Inverter Time and Date. It may be easier to tap the slider next to "Follow Phone Time". Then tap Next in the top right corner. This will set the inverter to match your phone.

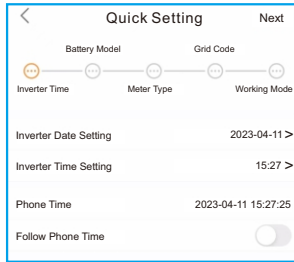

B. Battery Model: Now select the battery model connected to the inverter. This choice must be based on the battery model that is actually connected to the inverter. If there is no battery connected for the moment, select "No Battery" to avoid potential alarms codes.

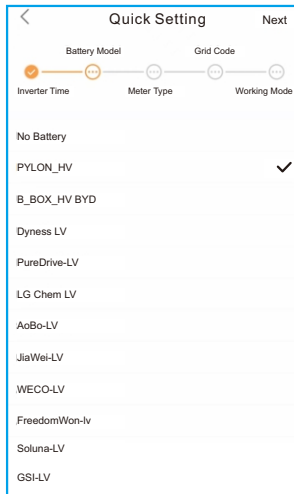

C. Meter Setting: Set both the Meter Type and the Meter Location. It is suggested to install the meter at the system grid connection point and select “Meter in Grid”. If there is no meter connected for the moment, please select “No Meter” to avoid alarms.

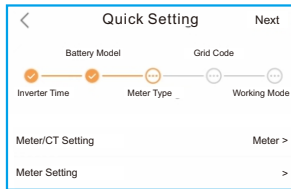

D. Grid Code: Please select the grid code based on the local grid network requirements.

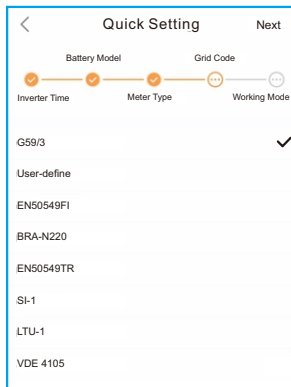

E. Work Mode: This is the energy storage operating mode. ALL modes first priority is to use the available PV power to support the home loads. The different modes determine what the second priority, or use of the excess PV power, will be. Select the desired mode, then tap the slider switch to turn the mode on. The switch will appear orange if it is enabled.

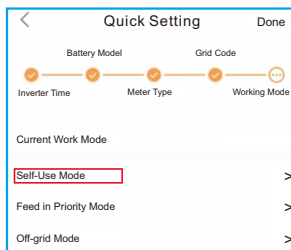

Self-Use Mode stores the excess PV power into the battery. If the battery is charged, or there is no battery, the excess PV power will be exported(sold)back to the utility company. If the system is set to not export any power, then the inverter will curtail the PV power(derate the inverter output power).

Feed in Priority Mode will ensure that the system exports any excess PV power after the home loads are supplied. If the export power quota has been met, then the remaining PV power will be stored in the battery. This mode should not be used if export power is going to be set to zero.

Off-Grid Mode is only to be used by systems that are not electrically connected to the grid at all. This mode is like Self-Use Mode, but the PV power will be curtailed if the battery is charged and the home load demand is lower than the amount of available PV power.

Backup Mode can be opened in the Self-Use or Feed in Priority Mode. What this mode does is ensure that the battery does not drain past the Reserve SOC(state-of-charge) percentage. The battery will cycle between 100% and the Reserve SOC, so if grid power is lost, the battery will have the Reserve SOC at the very least to carry the home through the outage.

Time of Use Switch is for customizing when the battery is allowed to charge and discharge power and at what rate, established by a current(amperage)setting. If this slider switch is turned on, the inverter will only use this schedule to determine when to charge and discharge the battery. If Allow Grid Charging is turned on, the inverter will use grid power to charge the battery only under two circumstances:(1) the battery drains to the Force Charge SOC. (2)Time of Use is enabled and there is not enough available PV power during the charge window to meet the current rate that is established.

Time of Use is for manual control of the battery charging/discharging. If Time of Use is turned off, charging/discharging is automatically regulated by the inverter.

< Self-Use Mode

Self-Use Mode Switch

Time of Use Switch

Time of Use Charge Current Set 50.0A >

Time of Use Discharge Current Set 50.0A >

Charge Time Slot 1 22:00 ~ 08:00 >

Discharge Time Slot 1 08:00 ~ 22:00 >

Charge Time Slot 2 00:00 ~ 00:00 >

Discharge Time Slot 2 00:00 ~ 00:00 >

Charge Time Slot 3 00:00 ~ 00:00 >

Discharge Time Slot 3 00:00 ~ 00:00 >

Charge Time Slot 4 00:00 ~ 00:00 >

Discharge Time Slot 4 00:00 ~ 00:00 >

Charge Time Slot 5 00:00 ~ 00:00 >

Discharge Time Slot 5 00:00 ~ 00:00 >

Charge Time Slot 6 00:00 ~ 00:00 >

Discharge Time Slot 6 00:00 ~ 00:00 >

Allow Grid Charging

Backup Mode Switch

Reserved SOC 80% >

< Feed in Priority Mode

Feed in Priority Mode Switch

Time of Use Switch

Time of Use Charge Current Set 135.0A >

Time of Use Discharge Current Set 135.0A >

Charge Time Slot 1 00:00 ~ 01:00 >

Discharge Time Slot 1 01:00 ~ 02:00 >

Charge Time Slot 2 02:00 ~ 04:00 >

Discharge Time Slot 2 04:00 ~ 06:00 >

Charge Time Slot 3 06:00 ~ 10:00 >

Discharge Time Slot 3 10:00 ~ 11:00 >

Charge Time Slot 4 11:00 ~ 14:00 >

Discharge Time Slot 4 14:00 ~ 17:00 >

Charge Time Slot 5 17:30 ~ 18:00 >

Discharge Time Slot 5 18:00 ~ 22:55 >

Charge Time Slot 6 23:00 ~ 23:30 >

Discharge Time Slot 6 23:30 ~ 00:00 >

Allow Grid Charging

Backup Mode Switch

Reserved SOC 80% >

< Off-Grid Mode

Off-grid Mode Switch

Off-grid Overdischarge SOC 30% >

5.6 APP Interface

5.6.1 APP Interface Structure

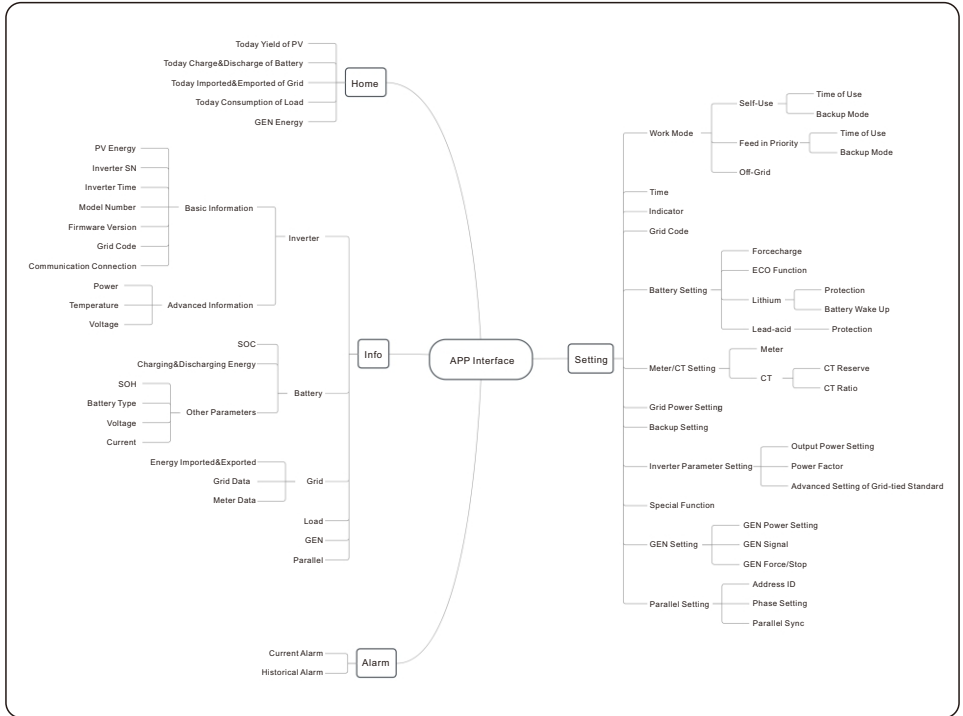

5.6.2 Home

The home page can display the working state, Today Yield of PV, Today Imported/Exported of Grid, Today Charged/Discharged of Battery ,Today Consumption of household electricity and Today GEN yield. At the bottom of page are four submenus: Home, Info, Alarm and Settings.

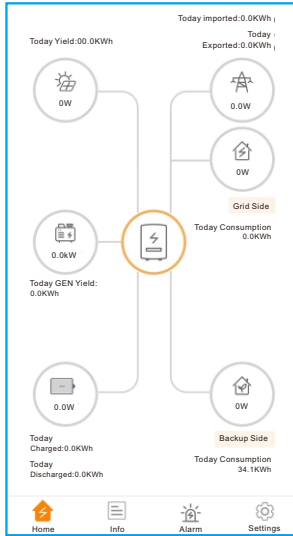

5.6.3 Information

The Info page breaks down into four categories: Inverter, Battery, Grid, and Load.

Inverter: inverter power production history, PV voltages and currents, inverter information (serial number, model number, and firmware version), grid code, and alarm code history.

There are two additional information in the inverter page:

GEN Information: generator power, today and total generator yield, and warning information.

Parallel Information: information includes inverter, battery, grid and load.

Battery: battery model and status, battery voltage and current.

Grid: power imported and exported, AC grid voltage, frequency, and amperage.

Load: power being consumed by the home loads and backup loads.

Inverter	Battery	Grid	Load
Total Yield		221kWh	
14.2kWh	191kWh	221kWh	
Today Yield	This Month Yield	This Year Yield	
12.8kWh	30kWh	0kWh	
Yesterday Yield	Last Month Yield	Last Year Yield	
View Historical Yield >			
Total PV Input Power		865W	
	Voltage	Current	Power
Pv1	432.6V	2.0A	865.20W
Pv2	0.0V	0.0A	0.00W
Inverter SN	103115022B100041		
Inverter Time	2022-12-23 15:32:03		
Rated Power	6kW		
Model Number	3115		
DSP Firmware Version	V2		
HMI Firmware Version	V1		
HMI Firmware Subversion	Vd		
Grid Code	G59/3		
Communication Connection	>		
Advanced Information	>		

Inverter	Battery	Grid	Load
49W	99% Battery SOC		
Discharge Power	Charged		Discharged
Today	6.8kWh	0.2kWh	
Total	1830kWh	1536kWh	
Other Parameters(From BMS)			
Battery SOH	100%		
Battery Model	Dyness LV		
BMS Status	Normal		
Battery Voltage BMS	50.28V		
Battery Current BMS	0.0A		
BMS Charge Current Limit	10.0A		
BMS Discharge Current Limit	75.0A		
Other Parameters(From inverter)			
Battery Voltage	49.8V		
Battery Current	1.0A		
OverVoltage Protection Value	60.0V		
UnderVoltage Protection Value	42.0V		
Battery Equalization Voltage	53.5V		

Inverter	Battery	Grid	Load
	Exported	Imported	
Today	0.0kWh	0.0kWh	
Yesterday	0.0kWh	0.0kWh	
Total	1kWh	0kWh	
Grid Data			
Power			-1399W
Voltage			220.8V
Frequency			49.95Hz

Inverter	Battery	Grid	Load
Grid Side			
Grid Load Power(Active)			0W
Total Grid Load Consumption			0kWh
Today Grid Load Consumption			0.0kWh
This Month Grid Load Consumption			0kWh
This Year Grid Load Consumption			0kWh
Backup Side			
Backup Load Power(Active)			2119W
Total Backup Load Consumption			1527kWh
Today Backup Load Consumption			34.2kWh
This Month Backup Load Consumption			1202kWh
This Year Backup Load Consumption			1527kWh

5.6.4 Alarm

The alarm page can display the current alarm and the historical alarm.

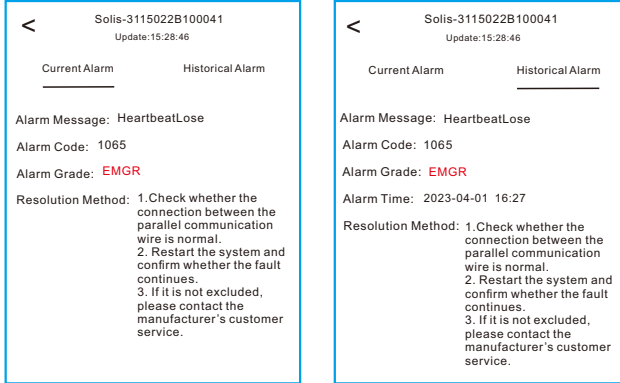

5.6.5 Settings

Mode Setting

The interface can display the current work mode, Self-Use/Feed in Priority/Off-Grid. Please refer to page xxx for specific introduction.

Battery Setting

Battery Model: select the battery model to be connected.

Peak-shaving setting: If the switch is enable, the power of force charging will be dynamically adjusted.

Five samples to be clear: (Forcecharge Limited Power Setting=4kW)

If the load=3kW,PV=0kW,P_forcecharge=P_Grid(4kW)-P_Load(3kW)=1kW.

If the load=10kW,PV=0kW,P_forcecharge=0kW,P_Grid=P_Load=10kW.

ECO Function: If PV power is lower than 100W and SOC falls below overdischarge SOC, the inverter will turn off the grid relays and IGBT switching. If forcecharge SOC is reached, it will connect back to grid and charge battery back to overdischarge SOC, then turn off again.

Battery wake up: After Battery wake up command, the inverter powers the DC battery port using Battery Wakeup Voltage and low AMP till BMS communication of battery will be restored and within awaken time.

Over-discharge SOC: When the battery is discharged to the over-discharge soc, the battery will nor discharge actively.(Due to the internal current, conduction, there is a small self-consumption power, if not charged for a long time, the SOC will slowly continue to decline.)

Force-charge SOC: Due to the battery power consumption, when the over-discharge SOC drops to the force-charge SOC, the inverter will directly charge the battery according to the maximum battery charging current until the battery SOC reaches the over-discharge SOC. (The charging power is not limited to sources, which may be from PV or from the grid. If “Charging from grid” is set to “Not Allow”, the charging logic may not be implemented.) It is not recommended to set the over-discharge & force-charge SOC to the same value, which may cause frequent charging and discharging.

GEN_Start_SOC/Volt: If SOC/Volt reaches GEN_Start_SOC/Volt, the generator can be started.

GEN_Exit_SOC/Volt: If SOC/Volt reaches GEN_Exit_SOC/Volt, the generator can be stopped.

Battery Setting	
Battery Model	PYLON_LV >
Peak-shaving Setting	<input type="checkbox"/>
Max. grid power when Forcecharging	500W >
Max. grid power when Forcecharging (Parallel)	0W >
ECO Function	<input type="checkbox"/>
Overdischarge SOC	20% >
Forcecharge SOC	10% >
Battery Overvoltage Protection Setting	60.0V >
Battery Undervoltage Protection Setting	42.0V >
GEN_Start_SOC	25% >
GEN_Exit_SOC	80% >
Battery Wake Up	>
Awaken Voltage	40.0V >
Awaken Time	20s >

Battery Setting	
Battery Model	Lead Acid >
Peak-shaving Setting	<input type="checkbox"/>
Max. grid power when Forcecharging	500W >
Max. grid power when Forcecharging (Parallel)	0W >
ECO Function	<input type="checkbox"/>
Battery Capacity	200Ah >
Max Charging Current	100.0A >
Max Discharging Current	100.0A >
Battery Overvoltage Protection Setting	60.0V >
Battery Undervoltage Protection Setting	42.0V >
Overdischarge Voltage	44.5V >
Force Voltage	43.8V >
GEN_Start_Volt	48.5V >
GEN_Exit_Volt	52.0V >
Equalization Voltage	56.4V >
Lead Acid TEMP CO	72mV/°C >
Environment temperature	Normal temper... >

Meter/CT Setting

You can select meter or CT for system measurement.

Meter Type: Please select a correct type. The wrong option may cause the meter RS485 communication Failed. If the battery and meter are not connected, please select the “NO Meter” to shield the alarm of meter communication fault.

CT Reverse: If the direction is wrong, the sampling current of CT will be reversed when calculating the power.

CT Ratio: CT ratio is adjustable.

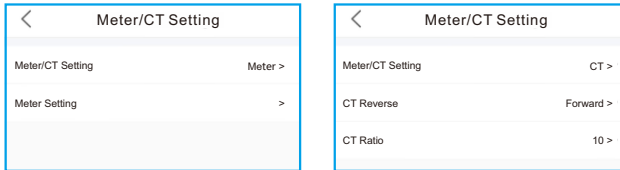

Grid Power Setting

System Export Power/Current: This is the amount of power/current the inverter is permitted to export(or sell) back to the utility company. If you do not want the system exporting power, this setting must be configured.

Failsafe Switch: Enabling the Failsafe switch will mean that the inverter will not produce any P power if the inverter loses communication with the meter.

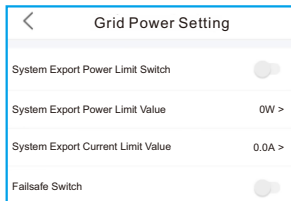

Backup Setting

Backup Voltage Setting: This is the voltage designated to the backup loads in the event of a grid power loss.

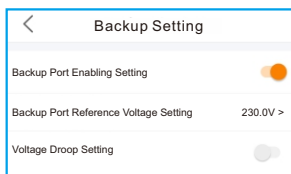

Generator Setting

With Generator: Please turn it on if the generator is ready to work.

GEN Power Setting: GEN Rated Power/GEN Max.Charge Power.

Generator Position: Grid Port/GEN Port.

Grid Port Powered By: If the generator is connected in Grid Port and the generator works , please select “Generator”.

GEN Signal: If the generator can automatic start-stop,turn on the switch, once the generator start condition is reached,the inverter will start the generator automatically.

GEN Force: If $GEN_Start_SOC < SOC < GEN_Exit_SOC / GEN_Start_Volt < Volt < GEN_Exit_Volt$, the generator can be forced to start.

GEN Stop: If $GEN_Start_SOC < SOC < GEN_Exit_SOC / GEN_Start_Volt < Volt < GEN_Exit_Volt$, the generator can be forced to stop.

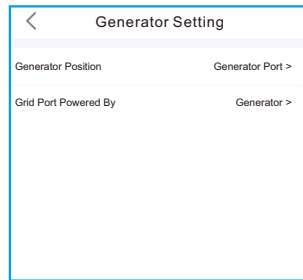
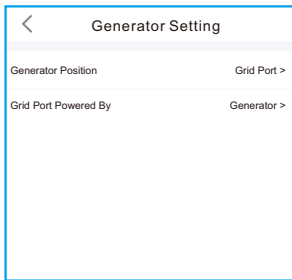
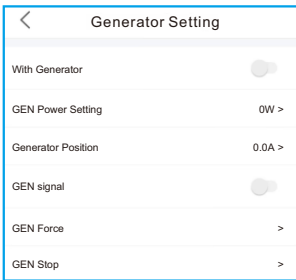

Parallel Setting

Parallel Mode: Single/Parallel

Address ID: 1 to 6

Manual Set Master/Slave: Address ID 1 is Master, the others is Slave.

Inverter Connected Phase Setting: Single Phase(single phase system)/
Phase A(Three Phase)/Phase B(Three Phase)/Phase C(Three Phase)

Total number of hybrid inverters connected: 0-6

Parallel Sync: The parameters of the master will be synchronized to the slaves, and some parameters of the slave cannot be set.

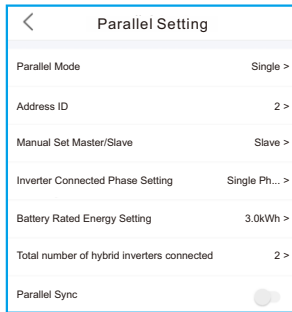

The inverter commissioning process has now been completed. It is recommended to monitor the system closely over the next week to ensure that everything is working as it should. Please refer to the Solis data logger manual for assistance with registering a new plant on SolisCloud.



NOTE:

A full factory reset can be done, if needed. This function can be found in the Special Setting Function menu within the Settings tab.

Solis S6 Series inverter does not require any regular maintenance. However, cleaning the heatsink will help the inverter dissipate heat and increase the lifetime of inverter. The dirt on the inverter can be cleaned with a soft brush.



CAUTION:

Do not touch the surface when the inverter is operating. Some parts may be hot and could cause burns. Turn OFF the inverter and let it cool down before you do any maintenance or cleaning of inverter.

The Screen and the LED status indicator lights can be cleaned with cloth if they are too dirty to be read.



NOTE:

Never use any solvents, abrasives, or corrosive materials to clean the inverter.

6.1 Smart O&M

In order to improve our products and provide you with higher quality services, this device has a built-in data logging module for collecting relevant information during operation (such as power generation data, fault data)

Commitment:

1. We will only collect, use and process your device information for the purpose of improving our products and services.
2. We will take all reasonable and feasible measures to ensure that no irrelevant information is collected and we will protect your device information.
3. We will not share, transfer or disclose the collected device information with any company, organization or individual.
4. When we stop operating products or services, we will stop collecting your device information in a timely manner.
5. If you do not want to provide such information, you can notify our company to turn off this function, which will not affect your normal use of other functions of the product.

7. Troubleshooting

Message Name	Information Description	Troubleshooting Suggestion
Off	Control device to shutdown	1. Turn on the device in the ON/OFF Setting.
LmtByEPM	The device's output is under controlled	<ol style="list-style-type: none"> 1. Confirm whether the inverter is connected to an external EPM/meter to prevent reverse current. 2. Confirm whether the inverter is controlled by an external third-party device. 3. Confirm whether the power setting of the inverter power control is limited. 4. Verify settings in section 6.6.7 and check your meter readings.
LmtByDRM	DRM Function ON	1. No need to deal with it.
LmtByTemp	Over temperature power limited	1. No need to deal with it, the device is in normal operation.
LmtByFreq	Frequency power limited	
LmtByVg	The device is in the Volt-Watt mode	<ol style="list-style-type: none"> 1. Due to the requirements of local safety regulations, when the grid voltage is high, the Volt-watt working mode is triggered, which generally does not need to be dealt with. 2. Inverter factory test errors causing this mode to open, if you need to close, you can close this mode in LCD, set the process: Main menu → Advanced Settings → Password 0010 → STD mode settings → Working Mode → Working mode: NULL → Save and exit.
LmtByVar	The device is in the Volt-Var mode of operation	<ol style="list-style-type: none"> 1. Due to the requirements of local safety regulations, when the grid voltage is high, the Volt-watt working mode is triggered, which generally does not need to be dealt with. 2. Inverter factory test errors causing this mode to open, if you need to close, you can close this mode in LCD, set the process: Main menu → Advanced Settings → Password 0010 → STD mode settings → Working Mode → Working mode: NULL → Save and exit.
LmtByUnFr	Under frequency limit	1. No need to deal with it.
Standby	Bypass run	
StandbySynoch	Off grid status to On grid status	
GridToLoad	Grid to load	

Message Name	Information Description	Troubleshooting Suggestion
Surge Alarm	On-site grid surge	1. Grid side fault, restart the device. If it is still not eliminated, please contact the manufacturer's customer service.
OV-G-V01	Grid voltage exceeds the upper voltage range	1. Confirm whether the power grid is abnormal. 2. Confirm that the AC cable is properly connected. 3. Restart the system and check if the fault persists.
UN-G-V01	Grid voltage exceeds the lower voltage range	
OV-G-F01	Grid frequency exceeds the upper frequency range	
UN-G-F01	Grid frequency exceeds the lower frequency range	
G-PHASE	Unbalanced grid voltage	
G-F-GLU	Grid voltage frequency fluctuation	
NO-Grid	No grid	
OV-G-V02	Grid transient overvoltage	
OV-G-V03	Grid transient overvoltage	1. Restart the system, confirm if that the fault continues.
IGFOL-F	Grid current tracking failure	1. Confirm whether the power grid is abnormal. 2. Confirm that the AC cable is properly connected. 3. Restart the system and check if the fault persists.
OV-G-V05	Grid voltage RMS instantaneous overvoltage fault	
OV-G-V04	Grid voltage exceeds the upper voltage range	
UN-G-V02	Grid voltage exceeds the lower voltage range	
OV-G-F02	Grid frequency exceeds the upper frequency range	
UN-G-F02	Grid frequency exceeds the lower frequency range	
NO-Battery	Battery is not connected	1. Check on information page 1 – Verify the battery voltage is within standards. 2. Measure battery voltage at plug.
OV-Vbackup	Inverting overvoltage	1. Check whether the backup port wiring is normal 2. Restart the system, confirm that the fault continues.
Over-Load	Load overload fault	1. Backup load power is too large, or some inductive load startup power is too large, need to remove some backup load, or remove the inductive load on the backup.

Message Name	Information Description	Troubleshooting Suggestion
BatName-FAIL	Wrong battery brand selection	1. Confirm whether the battery model selection is consistent with the actual one.
CAN Fail	CAN Fail	1. Can failure is a failure of communication between inverter and battery. Check cable conditions. Check to ensure you have it plugged in on the CAN port of the battery and inverter. Check that you are using the right cable. Some batteries require a special battery from the battery manufacturer.
OV-Vbatt	Battery overvoltage detected	1. Verify battery voltage is within standards. Measure battery voltage at inverter connection point. Contact your battery manufacturer for further service.
UN-Vbatt	Battery undervoltage detected	1. Restart the system and check if the fault persists. If it is still not eliminated, please contact the manufacturer's customer service.
Fan Alarm	Fan alarm	1. Check if the internal fan is working correctly or jammed.
OV-DC01 (1020 DATA:0001)	DC 1 input overvoltage	1. Check if the PV voltage is abnormal 2. Restart the system, confirm that the fault continues
OV-DC02 (1020 DATA:0002)	DC 2 input overvoltage	
OV-BUS (1021 DATA:0000)	DC bus overvoltage	1. Restart the system, confirm that the fault continues.
UN-BUS01 (1023 DATA:0001)	DC bus undervoltage	
UNB-BUS (1022 DATA:0000)	DC bus unbalanced voltage	
UN-BUS02 (1023 DATA:0002)	Abnormal detection of DC bus voltage	
DC-INTF. (1027 DATA:0000)	DC hardware overcurrent (1, 2, 3, 4)	1. Check if the DC wires are connected correctly without loose connection.
OV-G-I (1018 DATA:0000)	Aphase RMS value overcurrent	1. Confirm that the grid is abnormal. 2. Confirm that the AC cable connection is not abnormal. 3. Restart the system, confirm that the fault continues.
OV-DCA-I (1025 DATA:0000)	DC 1 average overcurrent	1. Restart the system, confirm that the fault continues.
OV-DCB-I (1026 DATA:0000)	DC 2 average overcurrent	
GRID-INTF. (1030 DATA:0000)	AC hardware overcurrent (abc phase)	

7. Troubleshooting

Message Name	Information Description	Troubleshooting Suggestion
DCInj-FAULT (1037 DATA:0000)	The current DC component exceeds the limit	<ol style="list-style-type: none"> 1. Confirm that the grid is abnormal. 2. Confirm that the AC cable connection is not abnormal. 3. Restart the system, confirm that the fault continues.
IGBT-OV-I (1048 DATA:0000)	IGBT overcurrent	<ol style="list-style-type: none"> 1. Restart the system, confirm that the fault continues.
OV-TEM (1032 DATA:0000)	Module over temperature	<ol style="list-style-type: none"> 1. Check whether the surrounding environment of the inverter has poor heat dissipation. 2. Confirm whether the product installation meets the requirements.
RelayChk-FAIL (1035 DATA:0000)	Relay failure	<ol style="list-style-type: none"> 1. Restart the system, confirm that the fault continues.
UN-TEM (103A DATA:0000)	Low temperature protection	<ol style="list-style-type: none"> 1. Check the working environment temperature of the inverter. 2. Restart the system to confirm if the fault continues.
PV ISO-PRO01 (1033 DATA:0001)	PV negative ground fault	<ol style="list-style-type: none"> 1. Check whether the PV strings have insulation problems. 2. Check whether the PV cable is damaged.
PV ISO-PRO02 (1033 DATA:0002)	PV positive ground fault	
12Power-FAULT (1038 DATA:0000)	12V undervoltage failure	<ol style="list-style-type: none"> 1. Check current leakage to ground. Verify your grounding. Verify all wires are in good condition and not leaking current to ground.
ILeak-PRO01 (1034 DATA:0001)	Leakage current failure 01 (30mA)	
ILeak-PRO02 (1034 DATA:0002)	Leakage current failure 02 (60mA)	
ILeak-PRO03 (1034 DATA:0003)	Leakage current failure 03 (150mA)	
ILeak-PRO04 (1034 DATA:0004)	Leakage current failure 04	
ILeak_Check (1039 DATA:0000)	Leakage current sensor failure	
GRID-INTF02 (1046 DATA:0000)	Power grid disturbance 02	<ol style="list-style-type: none"> 1. Confirm whether the grid is seriously distorted. 2. Check whether the AC cable is connected reliably.
OV-Vbatt-H/ OV-BUS-H (1051 DATA:0000)	Battery overvoltage hardware failure / VBUS	<ol style="list-style-type: none"> 1. Check if the battery circuit breaker is tripping. 2. Check if the battery is damaged.

Message Name	Information Description	Troubleshooting Suggestion
OV-ILLC (1052 DATA:0000)	LLC hardware overcurrent	1. Check whether the backup load is overloaded. 2. Restart the system, confirm that the fault continues.
INI-FAULT (1031 DATA:0000)	AD zero drift overlink	1. Restart the system, confirm that the fault continues.
DSP-B-FAULT (1036 DATA:0000)	The master-slave DSP communication is abnormal	
AFCI-Check (1040 DATA:0000)	AFCI self-test failure	
ARC- FAULT (1041 DATA:0000)	AFCI failure	1. Verify connections are tight within your PV system. Arc fault settings can be changed in advanced settings if further adjustment is necessary.

Table 7.1 Fault message and description



NOTE:

If the inverter displays any alarm message as listed in Table 8.1; please turn off the inverter and wait for 5 minutes before restarting it .
If the failure persists, please contact your local distributor or the service center.

Please keep ready with you the following information before contacting us.

1. Serial number of Solis Singles Phase Inverter;
2. The distributor/dealer of Solis Singles Phase Inverter (if available);
3. Installation date.
4. The description of the problem together with necessary information, pictures, attachment.
5. The PV array configuration (e.g. number of panels, capacity of panels, number of strings, etc.);
6. Your contact details.

8. Specifications

Technical Data	S6-EH1P3K-L-PLUS	S6-EH1P3.6K-L-PLUS
Input DC (PV side)		
Recommended max. PV power	4800W	5760W
Max. input voltage	500V	
Rated voltage	330V	
Start-up voltage	90V	
MPPT voltage range	90-435V	
Full load MPPT voltage range	150-435V	180-435V
Max. inverter backfeed current to the array	0A	
Max. input current	16A/16A	
Max. short circuit current	20A/20A	
MPPT number/Max input strings number	2/2	
Battery		
Battery Type	Li-ion / Lead-acid	
Battery Voltage range	40 - 60V	
Max. charge / discharge power	3kW	3.6kW
Max. charge / discharge current	70A	80A
Communication	CAN/RS485	
Output AC(Grid side)		
Rated output power	3kW	3.6kW
Max. apparent output power	3kVA	3.6kVA
Operation phase	1/N/PE	
Rated grid voltage	220 V/230 V	
The grid voltage range	187-253 V	
Rated grid frequency	50 Hz/60 Hz	
AC grid frequency range	45-55 Hz/55-65 Hz	
Rated grid output current	13.7 A/13.1A	16.4 A/15.7 A
Max. output current	13.7 A	16.4 A
Maximum output fault current	60 A	
Inrush current	217A 10us	
Power Factor	> 0.99 (0.8 leading - 0.8 lagging)	
THDi	<2%	

8. Specifications

Technical Data	S6-EH1P3K-L-PLUS	S6-EH1P3.6K-L-PLUS
AC Input (For grid port and Gen port)		
Input voltage range	187-253V	
Max. input current	20.0 A	25.0 A
Frequency range	45-55 Hz/ 55-65Hz	
Output AC(Back-up)		
Rated output power	3kW	3.6kW
Max. output power	3kW	3.6kW
Max. apparent output power	2 times of rated power, 10 S	
Back-up switch time	<4ms	
Rated output voltage	1/N/PE, 220 V/230 V	
Rated frequency	50Hz/60Hz	
Rated. output current	13.7 A/13.1 A	16.4 A/15.7 A
Max. output current	13.7 A	16.4 A
Max. AC Passthrough current	35.0 A	
THDv(@linear load)	2%	
Efficiency		
Max. efficiency	97.5%	
EU efficiency	96.2%	
Protection		
Ground fault monitoring	Yes	
Residual current monitoring	Yes	
Integrated AFCI	Yes	
DC reverse polarity protection	Yes	
Protection class / Over voltage category	I / II(PV and BAT), III (MAINS and BACKUP and GEN)	

8. Specifications

Technical Data	S6-EH1P3K-L-PLUS	S6-EH1P3.6K-L-PLUS
General data		
Dimensions(W/H/D)	406*560*205mm	
Weight	21.6kg	
Topology	High frequency insulation (for battery)	
Operation temperature range	-40°C ~ +60°C	
Ingress protection	IP66	
Cooling concept	Natural convection	
Environmental category	Indoor and outdoor	
Relative humidity range	0-95%	
Pollution degree	3	
Max.operation altitude	4000m	
Grid connection standard	NRS 097-2-1, IEC 62116, IEC 61727, IEC 60068, IEC 61683, EN 50530, MEA, PEA	
Safety/EMC standard	IEC/EN 62109-1/-2, EN 61000-6-2/-3	
Features		
DC connection	MC4 plug(PV port)/Terminal Block(BAT port)	
AC connection	Terminal Block	
Display	LED+APP	
Communication	RS485,CAN, Optional: Wi-Fi, GPRS, LAN	
Warranty	5 years standard (extend to 20 years)	

8. Specifications

Technical Data	S6-EH1P5K-L-PLUS	S6-EH1P6K-L-PLUS
Input DC (PV side)		
Recommended max. PV power	8000W	9600W
Max. input voltage	500V	
Rated voltage	330V	
Start-up voltage	90V	
MPPT voltage range	90-435V	
Full load MPPT voltage range	250-435V	300-435V
Max. inverter backfeed current to the array	0A	
Max. input current	16A/16A	
Max. short circuit current	20A/20A	
MPPT number/Max input strings number	2/2	
Battery		
Battery Type	Li-ion / Lead-acid	
Battery Voltage range	40 - 60V	
Max. charge / discharge power	5kW	6kW
Max. charge / discharge current	112A	135A
Communication	CAN/RS485	
Output AC(Grid side)		
Rated output power	5kW	6kW
Max. apparent output power	5kVA	6kVA
Operation phase	1/N/PE	
Rated grid voltage	220 V/230 V	
The grid voltage range	187-253 V	
Rated grid frequency	50 Hz/60 Hz	
AC grid frequency range	45-55 Hz/55-65 Hz	
Rated grid output current	22.8 A/21.8 A	27.3 A/26.1 A
Max. output current	22.8 A	27.3 A
Maximum output fault current	80 A	
Inrush current	217A 10us	
Power Factor	> 0.99 (0.8 leading - 0.8 lagging)	
THDi	<2%	

8. Specifications

Technical Data	S6-EH1P5K-L-PLUS	S6-EH1P6K-L-PLUS
AC Input (For grid port and Gen port)		
Input voltage range	187-253V	
Max. input current	32.0 A	40.0 A
Frequency range	45-55 Hz/ 55-65Hz	
Output AC(Back-up)		
Rated output power	5kW	6kW
Max. output power	5kW	6kW
Max. apparent output power	2 times of rated power, 10 S	
Back-up switch time	<4ms	
Rated output voltage	1/N/PE, 220 V/230 V	
Rated frequency	50Hz/60Hz	
Rated. output current	22.8 A/21.8 A	27.3 A/26.1 A
Max. output current	22.8 A	27.3 A
Max. AC Passthrough current	40.0 A	
THDv(@linear load)	2%	
Efficiency		
Max. efficiency	97.5%	
EU efficiency	96.2%	
Protection		
Ground fault monitoring	Yes	
Residual current monitoring	Yes	
Integrated AFCI	Yes	
DC reverse polarity protection	Yes	
Protection class / Over voltage category	I / II(PV and BAT), III (MAINS and BACKUP and GEN)	

8. Specifications

Technical Data	S6-EH1P5K-L-PLUS	S6-EH1P6K-L-PLUS
General data		
Dimensions(W/H/D)	406*560*205mm	
Weight	21.6kg	22.2kg
Topology	High frequency insulation (for battery)	
Operation temperature range	-40°C ~ +60°C	
Ingress protection	IP66	
Cooling concept	Natural convection	
Environmental category	Indoor and outdoor	
Relative humidity range	0-95%	
Pollution degree	3	
Max.operation altitude	4000m	
Grid connection standard	NRS 097-2-1, IEC 62116, IEC 61727, IEC 60068, IEC 61683, EN 50530, MEA, PEA	
Safety/EMC standard	IEC/EN 62109-1/-2, EN 61000-6-2/-3	
Features		
DC connection	MC4 plug(PV port)/Terminal Block(BAT port)	
AC connection	Terminal Block	
Display	LED+APP	
Communication	RS485,CAN, Optional: Wi-Fi, GPRS, LAN	
Warranty	5 years standard (extend to 20 years)	

8. Specifications

Technical Data	S6-EH1P8K-L-PLUS
Input DC (PV side)	
Recommended max. PV power	12800W
Max. input voltage	500V
Rated voltage	330V
Start-up voltage	90V
MPPT voltage range	90-435V
Full load MPPT voltage range	200-435V
Max. inverter backfeed current to the array	0A
Max. input current	32A/32A
Max. short circuit current	40A/40A
MPPT number/Max input strings number	2/4
Battery	
Battery Type	Li-ion / Lead-acid
Battery Voltage range	40 - 60V
Max. charge / discharge power	8kW
Max. charge / discharge current	190A
Communication	CAN/RS485
Output AC(Grid side)	
Rated output power	8kW
Max. apparent output power	8kVA
Operation phase	1/N/PE
Rated grid voltage	220 V/230 V
The grid voltage range	187-253 V
Rated grid frequency	50 Hz/60 Hz
AC grid frequency range	45-55 Hz/55-65 Hz
Rated grid output current	36.4 A/34.8 A
Max. output current	36.4 A
Maximum output fault current	132 A
Inrush current	217A 10us
Power Factor	> 0.99 (0.8 leading - 0.8 lagging)
THDi	<2%

8. Specifications

Technical Data	S6-EH1P8K-L-PLUS
AC Input (For grid port and Gen port)	
Input voltage range	187-253V
Max. input current	50.0 A
Frequency range	45-55 Hz/ 55-65Hz
Output AC(Back-up)	
Rated output power	8kW
Max. output power	8kW
Max. apparent output power	2 times of rated power, 10 S
Back-up switch time	<4ms
Rated output voltage	1/N/PE, 220 V/230 V
Rated frequency	50Hz/60Hz
Rated. output current	36.4 A/34.8 A
Max. output current	36.4 A
Max. AC Passthrough current	50.0 A
THDv(@linear load)	2%
Efficiency	
Max. efficiency	97.5%
EU efficiency	96.2%
Protection	
Ground fault monitoring	Yes
Residual current monitoring	Yes
Integrated AFCI	Yes
DC reverse polarity protection	Yes
Protection class / Over voltage category	I / II(PV and BAT), III (MAINS and BACKUP and GEN)

8. Specifications

Technical Data	S6-EH1P8K-L-PLUS
General data	
Dimensions(W/H/D)	406*560*215mm
Weight	22.2kg
Topology	High frequency insulation (for battery)
Operation temperature range	-40°C ~ +60°C
Ingress protection	IP66
Cooling concept	Intelligent cooling
Environmental category	Indoor and outdoor
Relative humidity range	0-95%
Pollution degree	3
Max.operation altitude	4000m
Grid connection standard	NRS 097-2-1, IEC 62116, IEC 61727, IEC 60068, IEC 61683, EN 50530, MEA, PEA
Safety/EMC standard	IEC/EN 62109-1/-2, EN 61000-6-2/-3
Features	
DC connection	MC4 plug(PV port)/Terminal Block(BAT port)
AC connection	Terminal Block
Display	LED+APP
Communication	RS485,CAN, Optional: Wi-Fi, GPRS, LAN
Warranty	5 years standard (extend to 20 years)

Frequently Asked Questions

Q1: Why I have "CAN Fail" Alarm on the inverter?

A: "CAN Fail" indicates the CAN communication between inverter and battery is lost. Please double check if your CAN cable is correctly connected and if your battery is power on.

Q2: Why I have "BATName-Fail" Alarm on the inverter ?

A: Please check in the "Battery Setting->Battery Model" setting and confirm you selected the correct battery option as the nameplate of your battery module.

Q3: Why I have "MET-SLT-Fail" Alarm on the inverter?

A: Please check in the "Meter Setting->Meter Type" setting and confirm you selected the correct meter option corresponding to your smart meter.

Q4: Why the power values on the screen are fluctuating very fast?

A: If your loads are changing drastically, the inverter will adjust its power accordingly. If you confirm the loads are stable while the inverter power is changing very fast, please double check your meter CT's direction and make sure the arrow is towards grid.

Q5: Why I have "OV-ILLC" Alarm on the inverter ?

A: OV-ILLC indicates there is an overcurrent issue on the internal LLC circuit. It could be transient status during extreme condition such as overload. If it happens constantly or too frequent and the extreme conditions have been excluded, please contact Solis service team.

Q6: Why I have "OV-BATT-H" Alarm on the inverter ?

A: OV-BATT-H indicates over voltage issue on the hardware of battery circuit. It could be caused by high battery voltage at full SOC, battery suddenly switching off, etc. If it happens constantly or too frequent and the extreme conditions have been excluded, please contact Solis service team.

Q7: Why I have "No-Battery" Alarm on the inverter?

A: Please double check if the battery power cables have been correctly connected and the battery breaker (on battery or external) has been turn on. If you don't want to connect the battery for now, please select the "No battery" option in "Battery Setting->Battery Model" to prevent the alarm to show up.

Ginlong Technologies Co., Ltd.

No. 188 Jinkai Road, Binhai Industrial Park, Xiangshan, Ningbo,
Zhejiang, 315712, P.R.China.

Tel: +86 (0)574 6578 1806

Fax: +86 (0)574 6578 1606

Email: info@ginlong.com

Web: www.ginlong.com

Please adhere to the actual products in case of any discrepancies in this user manual.

If you encounter any problem on the inverter, please find out the inverter S/N and contact us, we will try to respond to your question ASAP.